

DIGITAL AUDIO PROCESSOR

DP-K1

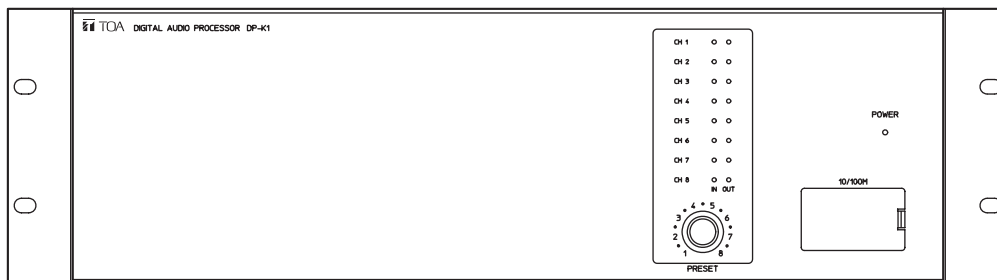

The various signal processing functions that the DP-K1 can implement are set using the supplied setting software.

The manual operation at the DP-K1 is only to recall the programmed setting state (preset memory) and to lock/unlock the knob to prevent accidental wrong operation.

For detailed descriptions of each function and its setting procedure, read the software setting instruction manual included in the supplied CD.

[Instruction manual configuration]

**Operating Instructions
(this book)**

Describes how to operate, install, and connect the DP-K1.

**Software Setup Manual
(included in the supplied CD)**

Describes the details of signal processing functions and how to set the functions using the setting software, and update the firmware.

Note: This book supports the following software versions.

Firmware: Version 2.00 or later

DP-K1 setting software: Version 2.00 or later

Thank you for purchasing TOA's Digital Audio Processor.

Please carefully follow the instructions in this manual to ensure long, trouble-free use of your equipment.

TABLE OF CONTENTS

1. SAFETY PRECAUTIONS	4
2. GENERAL DESCRIPTION	5
3. FEATURES	5
4. HANDLING PRECAUTIONS	5
5. NOMENCLATURE AND FUNCTIONS	
5.1. DP-K1 Digital Audio Processor	
[Front]	6
[Rear]	7
5.2. Optional Modules	
5.2.1. D-921F Microphone/Line Input Module	8
5.2.2. D-921E Microphone/Line Input Module	8
5.2.3. D-922F Microphone/Line Input Module	9
5.2.4. D-922E Microphone/Line Input Module	9
5.2.5. D-936R Stereo Input Module	9
5.2.6. D-923AE Digital Input Module	10
5.2.7. D-937SP Digital Input Module	10
5.2.8. D-971M Line Output Module	10
5.2.9. D-971E Line Output Module	11
5.2.10. D-971R Line Output Module	11
5.2.11. D-972AE Digital Output Module	11
5.2.12. D-961SP Digital Output Module	12
5.2.13. D-981 Remote Control Module	12
5.2.14. D-983 Remote Control Module	12
6. SIGNAL PROCESSING FUNCTIONS	13
7. OPERATIONS	
7.1. Recalling the Preset Memory	13
7.2. Locking and Unlocking the Preset Knob	13
8. PC CONNECTIONS	
8.1. Connections	14
8.2. Repositioning the Network Connection Terminal	15
9. RESTORING FACTORY DEFAULT SETTING	17
10. RACK MOUNTING	17
11. CONNECTIONS	
11.1. Connection Example	18
11.2. Removable Terminal Plug Connection	19
11.3. Ferrite Cable Clamp Attachment (For D-972AE only)	19
12. BLOCK DIAGRAM	20

13. LEVEL DIAGRAMS

13.1. Analog Input/Output	22
13.2. Digital Input/Output	22

14. SPECIFICATIONS

14.1. DP-K1	Digital Audio Processor	23
14.2. D-921F	Microphone/Line Input Module (Optional)	24
14.3. D-921E	Microphone/Line Input Module (Optional)	24
14.4. D-922F	Microphone/Line Input Module (Optional)	24
14.5. D-922E	Microphone/Line Input Module (Optional)	25
14.6. D-936R	Stereo Input Module (Optional)	25
14.7. D-923AE	Digital Input Module (Optional)	25
14.8. D-937SP	Digital Input Module (Optional)	25
14.9. D-971M	Line Output Module (Optional)	26
14.10. D-971E	Line Output Module (Optional)	26
14.11. D-971R	Line Output Module (Optional)	26
14.12. D-972AE	Digital Output Module (Optional)	26
14.13. D-961SP	Digital Output Module (Optional)	27
14.14. D-981	Remote Control Module (Optional)	27
14.15. D-983	Remote Control Module (Optional)	28

1. SAFETY PRECAUTIONS

- Before installation or use, be sure to carefully read all the instructions in this section for correct and safe operation.
- Be sure to follow all the precautionary instructions in this section, which contain important warnings and/or cautions regarding safety.
- After reading, keep this manual handy for future reference.

Safety Symbol and Message Conventions

Safety symbols and messages described below are used in this manual to prevent bodily injury and property damage which could result from mishandling. Before operating your product, read this manual first and understand the safety symbols and messages so you are thoroughly aware of the potential safety hazards.

WARNING

Indicates a potentially hazardous situation which, if mishandled, could result in death or serious personal injury.

CAUTION

Indicates a potentially hazardous situation which, if mishandled, could result in moderate or minor personal injury, and/or property damage.

When Installing the Unit

- Do not expose the unit to rain or an environment where it may be splashed by water or other liquids, as doing so may result in fire or electric shock.
- Use the unit only with the voltage specified on the unit. Using a voltage higher than that which is specified may result in fire or electric shock.
- Do not cut, kink, otherwise damage nor modify the power supply cord. In addition, avoid using the power cord in close proximity to heaters, and never place heavy objects -- including the unit itself -- on the power cord, as doing so may result in fire or electric shock.

When the Unit is in Use

- Should the following irregularity be found during use, immediately switch off the power, disconnect the power supply plug from the AC outlet and contact your nearest TOA dealer. Make no further attempt to operate the unit in this condition as this may cause fire or electric shock.
 - If you detect smoke or a strange smell coming from the unit.
 - If water or any metallic object gets into the unit
 - If the unit falls, or the unit case breaks
 - If the power supply cord is damaged (exposure of the core, disconnection, etc.)
 - If it is malfunctioning (no tone sounds.)
- To prevent a fire or electric shock, never open nor remove the unit case as there are high voltage components inside the unit. Refer all servicing to your nearest TOA dealer.
- Do not place cups, bowls, or other containers of liquid or metallic objects on top of the unit. If they accidentally spill into the unit, this may cause a fire or electric shock.

When Installing the Unit

- Never plug in nor remove the power supply plug with wet hands, as doing so may cause electric shock.
- When unplugging the power supply cord, be sure to grasp the power supply plug; never pull on the cord itself. Operating the unit with a damaged power supply cord may cause a fire or electric shock.
- Do not block the fan exhaust vent on the unit's rear and the ventilation slots on the bottom. Doing so may cause heat to build up inside the unit and result in fire.
- Avoid installing the unit in humid or dusty locations, in locations exposed to the direct sunlight, near the heaters, or in locations generating sooty smoke or steam as doing otherwise may result in fire or electric shock.
- Be sure to follow the instructions below when rack-mounting the unit. Failure to do so may cause a fire or personal injury.
 - Install the equipment rack on a stable, hard floor. Fix it with anchor bolts or take other arrangements to prevent it from falling down.
 - Use the screws supplied with the unit to mount on TOA's rack.
 - When connecting the unit's power cord to an AC outlet, use the AC outlet with current capacity allowable to the unit.
- Do not connect the 10/100M terminal with any cables such as a telephone line that may cause excessive voltage.

When the Unit is in Use

- Switch off the power, and unplug the power supply plug from the AC outlet for safety purposes when cleaning or leaving the unit unused for 10 days or more. Doing otherwise may cause a fire or electric shock.

2. GENERAL DESCRIPTION

The TOA DP-K1 is a 3U rack mountable Digital Audio Processor.

It features an Automatic Resonance Control function that automatically generates an optimum filter curve to improve sound clarity after measuring the acoustic characteristics in architectural space.

All of this function and other acoustic signal processing functions such as compressor and delay are set by a PC using the supplied setting software.

The settings can be stored in the unit's internal memory and the stored settings can be recalled from the unit without connecting the PC.

The setting software is included in the supplied CD-ROM or can be downloaded from our website at <http://www.toa-products.com/>.

3. FEATURES

- Acoustic control that improves sound clarity can be attained through simple operation.
- Signals are digitally processed, ensuring high-accuracy sound parameter settings.
- Modular construction permits flexible configuration of inputs and outputs, from 2-IN/4-OUT to 8-IN/8-OUT systems.
- Because 8 memories are built inside, stored data can be easily recalled without connecting a PC after setting completion.
- The preset knob-lock function prevents trouble resulting from wrong operation.

4. HANDLING PRECAUTIONS

- The supplied power supply cord is designed for exclusive use with the unit. Never use it with other equipment.
- Use the unit in locations where the temperature is between +5°C to +40°C (no condensation) and the humidity is less than 90%.
- The DP-K1 is a precision audio component. To prevent failure, avoid locations where the unit may be exposed to strong shocks or vibrations.
- To clean, be sure to first switch off the power, then wipe with a dry cloth. When extremely dirty, use a soft cloth dampened in neutral detergent. Never use benzene, thinner or chemically-treated towels, which may damage the unit's finish.

5. NOMENCLATURE AND FUNCTIONS

5.1. DP-K1 Digital Audio Processor

[Front]

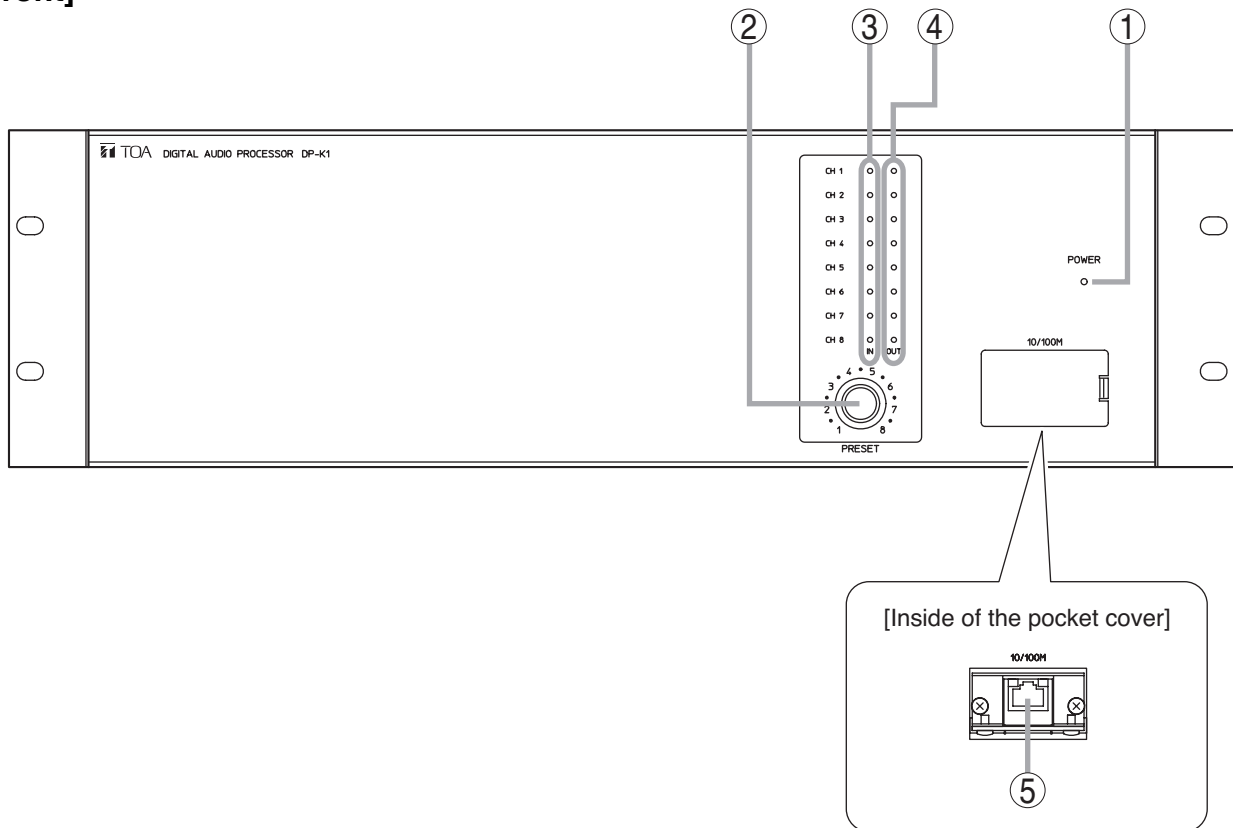

1. Power lamp

Lights when the power switch is set to ON.

2. Preset knob

Rotating this knob recalls the preset memory. Holding down it for 5 seconds or more locks or unlocks the knob.

The numbers and dots marked around the knob are LED indicators. They indicate the currently recalled memory number or communication state between the DP-K1 and the PC. For details, refer to p. 13 and 14.

3. Input channel indicators

Each indicator lights green when an input signal level is -40 dB or higher on the basis of the rated level.

4. Output channel indicators

Each indicator lights green when an output signal level is -40 dB or higher on the basis of the rated level.

5. Network connection terminal

Connects to 10 Base-T/100 Base-TX networks. (RJ45 Ethernet jack)

When connecting the unit to a switching hub, use a UTP Category 5 straight through cable fitted with RJ45 connectors.

When connecting the unit to a PC directly, use a UTP Category 5 cross cable fitted with RJ45 connectors.

Note

You can reposition this terminal to the rear panel. (Refer to the next page, No. 9 "Network connection terminal panel.")

[Rear]

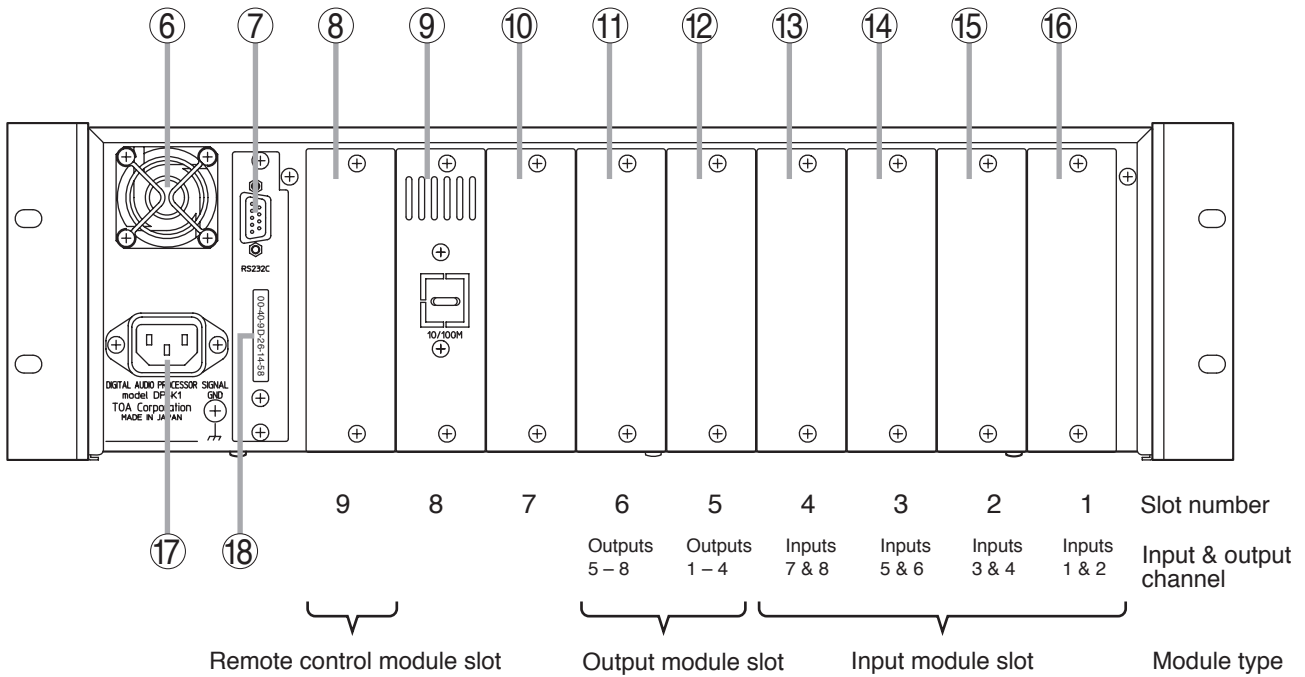

6. Cooling Fan

CAUTION
Do not block the fan exhaust vent. Doing so may cause heat to build up inside the unit and result in fire.

7. RS-232C Communication Port

The port is solely for the maintenance use.

8. Remote Control Module Slot

The remote control module's dedicated slot.

9. Network connection terminal panel

The blank panel is attached to the unit as shipped by the factory.

You can remove the network connection terminal from the front panel, and attach it to this panel.

For repositioning the terminal from the front panel, refer to p. 15.

10. Empty slot

Unused slot

11. Output module slot

Slot for output channels 5 – 8.

12. Output module slot

Slot for output channels 1 – 4.

13. Input module slot

Slot for input channels 7 and 8.

14. Input module slot

Slot for input channels 5 and 6.

15. Input module slot

Slot for input channels 3 and 4.

16. Input module slot

Slot for input channels 1 and 2.

17. AC inlet

Connect this inlet to the wall AC outlet using the supplied power cord.

18. MAC address

A 12-digit hexadecimal network address peculiar to the unit.

The MAC address is used to make the unit's network setting. Record it for later reference. For network setting procedures, refer to the software setting instruction manual included in the supplied CD.

5.2. Optional Modules

Notes

- Make sure that the power is switched OFF before attaching or detaching modules.
- To avoid failures due to static electricity, do not touch the parts or terminals on the circuit board of both the unit and module.
- Ensure that the module is installed and secured with screws in the correct position.
- Cover idle slots with the blank panels attached to the unit as shipped by the factory.
- Two silver slotted screws at the top and bottom of the front panel are handles used for module detachment. Never rotate them because they do not function as screws.

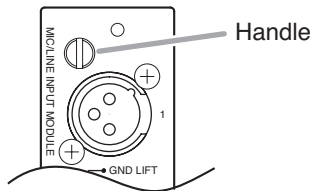

5.2.1. D-921F Microphone/Line Input Module

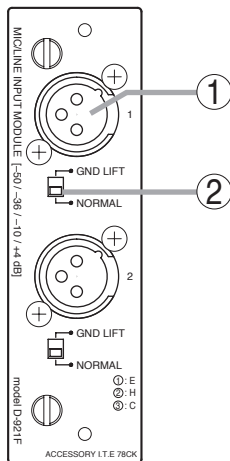

1. Monaural Input Terminal [1, 2] (XLR-3-31 equivalent)

Electronically-balanced input terminal. (Pin 1: Ground; Pin 2: Hot; Pin 3: Cold)
Use XLR-3-12C or equivalent for connection.
Input sensitivity (-50/-36/-10/+4 dB) and phantom power (+15 V) ON/OFF can be set by a PC using the setting software supplied with the DP-K1.

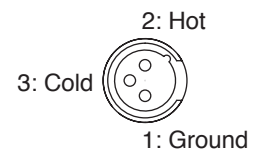

2. Ground Lift Switch [GND LIFT/NORMAL]

Hum noise may be generated due to ground loops created when the unit is connected to other equipment. Setting the switch to the GND LIFT position cuts the ground loop.

5.2.2. D-921E Microphone/Line Input Module

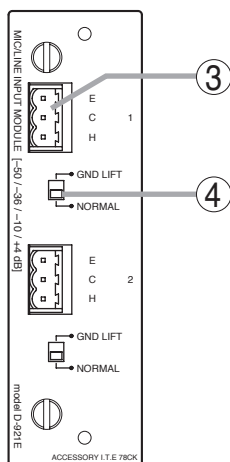

3. Monaural Input Terminal [1, 2]

Electronically-balanced, removable terminal block. (H: Hot; C: Cold; E: Ground)
Input sensitivity (-50/-36/-10/+4 dB) and phantom power (+15 V) ON/OFF can be set by a PC using the setting software supplied with the DP-K1.

4. Ground Lift Switch [GND LIFT/NORMAL]

Hum noise may be generated due to ground loops created when the unit is connected to other equipment. Setting the switch to the GND LIFT position cuts the ground loop.

Note

Be sure to use the supplied removable terminal plugs (3P) for connection.

5.2.3. D-922F Microphone/Line Input Module

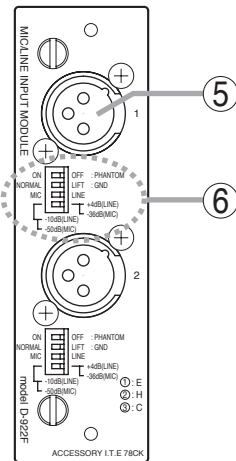

5. Monaural Input Terminal [1, 2] (XLR-3-31 equivalent)

Electronically-balanced input terminal. (Pin 1: Ground; Pin 2: Hot; Pin 3: Cold)
Use XLR-3-12C or equivalent for connection.

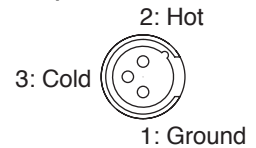

6. Input Sensitivity Switch [PHANTOM, GND LIFT, MIC/LINE]

4-pole switch. Enables phantom power (+15 V; ON/OFF, enabled only when set to the MIC position), ground lift and input sensitivity.
Input sensitivity: -36 or -50 dB (MIC mode) / -10 or +4 dB (LINE mode)

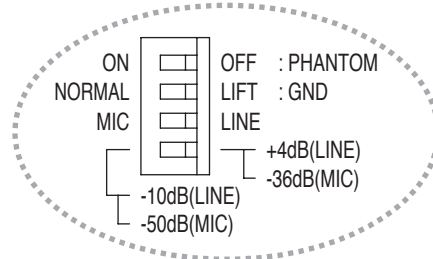

5.2.4. D-922E Microphone/Line Input Module

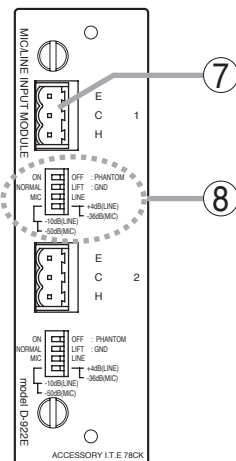

7. Monaural Input Terminal [1, 2]

Electronically-balanced, removable terminal block. (H: Hot; C: Cold; E: Ground)

Note

Be sure to use the supplied removable terminal plugs (3P) for connection.

8. Input Sensitivity Switch [PHANTOM, GND LIFT, MIC/LINE]

4-pole switch. Enables phantom power (+15V; ON/OFF, enabled only when set to the MIC position), ground lift and input sensitivity.
Input sensitivity: -36 or -50 dB (MIC mode) / -10 or +4 dB (LINE mode)

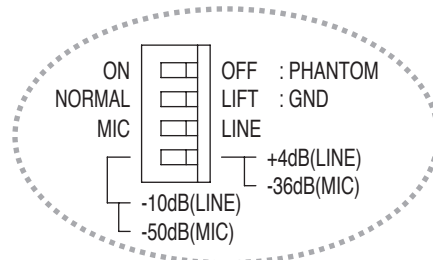

5.2.5. D-936R Stereo Input Module

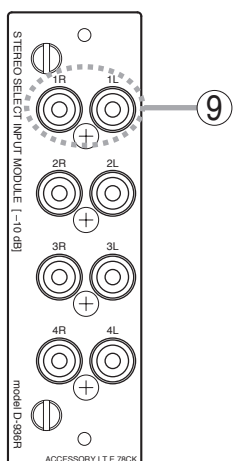

9. Stereo Input Terminal [1L/1R, 2L/2R, 3L/3R, 4L/4R]

Unbalanced, RCA pin jack stereo input terminals. Either a single stereo input can be selected from the 4 available stereo inputs or all 4 stereo channels can be mixed.

Mode setting and stereo selection are performed by a PC using the setting software supplied with the DP-K1. They can also be remotely selected by way of connected external equipment through the use of the control module.

Input signal level: -10 dB

5.2.6. D-923AE Digital Input Module

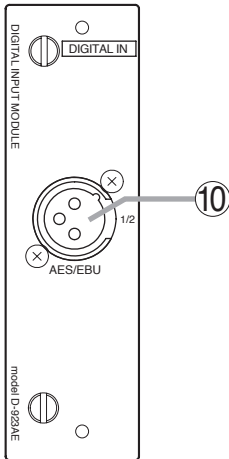

10. AES/EBU Digital Input Terminal [AES/EBU, 1/2] (XLR-3-31 equivalent)

Digital input terminal of AES/EBU format.
(Pin 1: Ground; Pin 2: Signal; Pin 3: Signal)

Use the XLR-3-12C or its equivalent for connection.

Note

Use a digital audio cable with characteristic impedance of 110 Ω for connection.

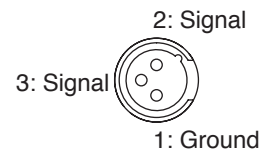

5.2.7. D-937SP Digital Input Module

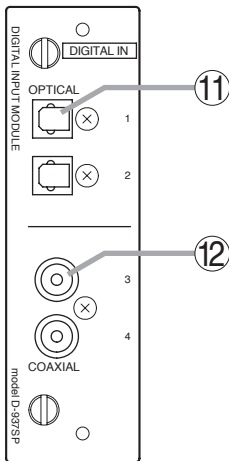

11. Optical Input Terminal [OPTICAL, 1,2]

Optical input terminal of S/PDIF format.

12. Coaxial Input Terminal [COAXIAL 3, 4]

Coaxial input terminal of S/PDIF format.

Notes

- Use a coaxial cable with characteristic impedance of 75 Ω for connection.
- One of four line inputs (stereo) is selected. Input selection is performed by a PC using the setting software supplied with the DP-K1.

5.2.8. D-971M Line Output Module

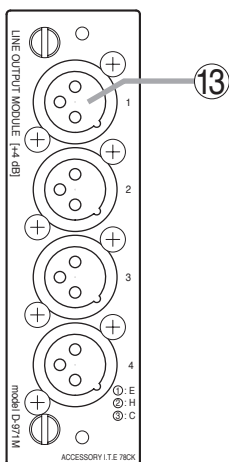

13. Monaural Output Terminal [1, 2, 3, 4] (XLR-3-32 equivalent)

Electronically-balanced output terminal.

(Pin 1: Ground; Pin 2: Hot; Pin 3: Cold)

Output signal level: +4dB

Use XLR-3-11C or equivalent for connection.

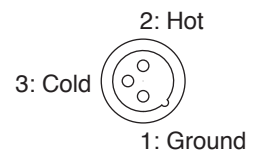

5.2.9. D-971E Line Output Module

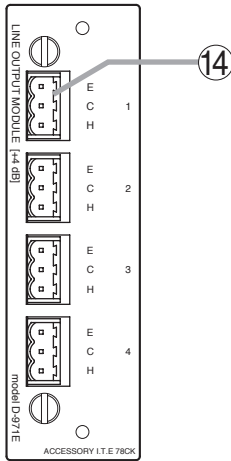

14. Monaural Output Terminal [1, 2, 3, 4]

Electronically-balanced, removable terminal block. (H: Hot; C: Cold; E: Ground.)

Output signal level: +4 dB

Note

Be sure to use the supplied removable terminal plugs (3P) for connection.

5.2.10. D-971R Line Output Module

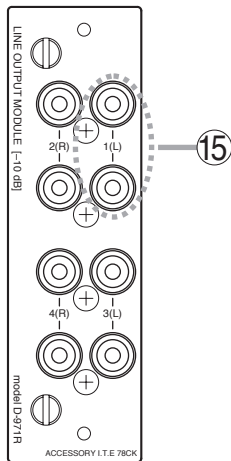

15. Monaural Output Terminals [1(L), 2(R), 3(L), 4(R)]

Unbalanced, RCA pin jack output terminals. Each output is equipped with a 2-channel splitter.

Output signal level: -10 dB

5.2.11. D-972AE Digital Output Module

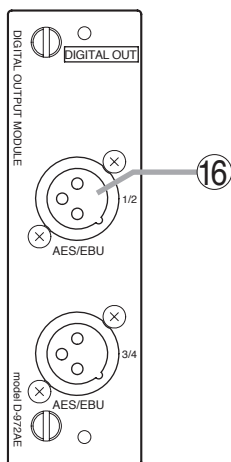

16. AES/EBU Digital Output Terminal [AES/EBU, 1/2] (XLR-3-32 or its equivalent)

Digital output terminal of AES/EBU format.

(Pin 1: Ground; Pin 2: Signal; Pin 3: Signal)

Use the XLR-3-11C or its equivalent for connection.

Note

Use the digital audio cable with characteristic impedance of 110 Ω for connection.

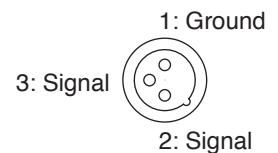

5.2.12. D-961SP Digital Output Module

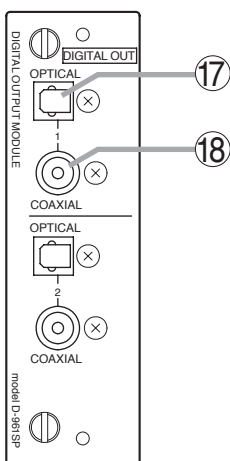

17. Optical Output Terminal [OPTICAL 1, 2]

Optical output terminal of S/PDIF format.

18. Coaxial Output Terminal [COAXIAL 1, 2]

Coaxial input/output terminal of S/PDIF format.

Note

Use a coaxial cable with characteristic impedance of 75 Ω for connection.

Each pair of the S/PDIF optical output and the coaxial RCA pin jack output delivers output in parallel.

5.2.13. D-981 Remote Control Module

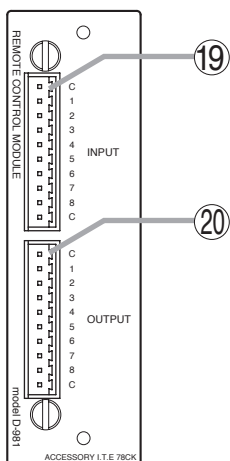

19. Contact Input Terminal [INPUT, C, 1, 2, 3, 4, 5, 6, 7, 8, C]

Removable terminal block, 8-circuit contact input terminal.

Individual contact functions are assigned by a PC using the setting software supplied with the DP-K1.

Note

Be sure to use the supplied removable terminal plugs (10P) for connection.

20. Contact Output Terminal [OUTPUT, C, 1, 2, 3, 4, 5, 6, 7, 8, C]

Removable terminal block, 8-circuit contact output terminal.

Individual contact functions are assigned by a PC using the setting software supplied with the DP-K1.

5.2.14. D-983 Remote Control Module

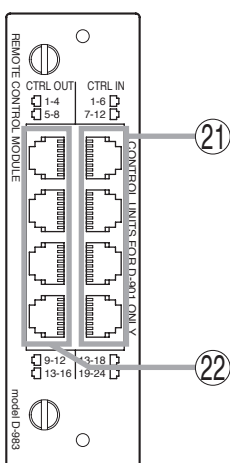

21. Contact Input Terminal [CTRL IN, 1-6, 7-12, 13-18, 19-24]

Six-circuit RJ45 contact input terminals.

Individual contact functions are assigned by a PC using the setting software supplied with the DP-K1.

Pin No.	CTRL IN			
	1-6	7-12	13-18	19-24
1	IN 1	IN 7	IN 13	IN 19
2	IN 2	IN 8	IN 14	IN 20
3	IN 3	IN 9	IN 15	IN 21
4	IN 6	IN 12	IN 18	IN 24
5	IN 5	IN 11	IN 17	IN 23
6	IN 4	IN 10	IN 16	IN 22
7	C	C	C	C
8	C	C	C	C

22. Contact Output Terminal [CTRL OUT, 1-4, 5-8, 9-2, 13-16]

Four-circuit RJ45 contact output terminals.

Individual contact functions are assigned by a PC using the setting software supplied with the DP-K1.

Pin No.	CTRL OUT			
	1-4	5-8	9-12	13-16
1	OUT 1	OUT 5	OUT 9	OUT 13
2	C 1	C 5	C 9	C 13
3	OUT 2	OUT 6	OUT 10	OUT 14
4	C 3	C 7	C 11	C 15
5	OUT 3	OUT 7	OUT 11	OUT 15
6	C 2	C 6	C 10	C 14
7	OUT 4	OUT 8	OUT 12	OUT 16
8	C 4	C 8	C 12	C 16

6. SIGNAL PROCESSING FUNCTIONS

The unit features the following signal processing functions.

- Automatic resonance control
- Compressor function
- Noise Gate function
- Filter function
- Crossover function
- Delay function

These function settings are performed using the dedicated setting software.

For detailed descriptions of the signal processing function, read the software setting instruction manual included in the supplied CD.

7. OPERATIONS

7.1. Recalling the Preset Memory

A PC with the dedicated software installed is required for setting the unit's parameters, but preset memory can be recalled from the unit even with the PC disconnected once these setting parameters are stored into 8 memories. (For preset function settings, refer to the software setting instruction manual included in the supplied CD.)

The operating procedure is as follows.

Step 1. Rotate the front-mounted preset knob to select the desired memory number.

The dots (LEDs) around the preset knob and the memory number currently recalled flash, and the number selected by the knob lights.

[Example of changing the memory number from 1 to 5]

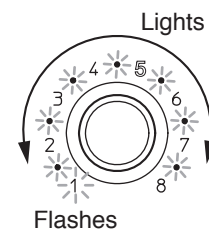

Step 2. Press the preset knob to recall the preset memory of the selected number.

The LEDs stop flashing and only the selected memory number lights.

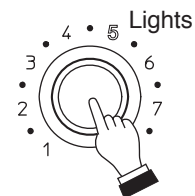

Notes

- When the preset knob remains unpressed for 60 seconds or more, the memory is not renewed, and so the original memory number stays as it is.
- The preset knob cannot be used during setting change while the PC is in communication with the DP-K1.

7.2. Locking and Unlocking the Preset Knob

You can lock the preset knob to prevent accidental wrong operation.

Hold down the preset knob on the front panel for 5 seconds or more to lock the knob.

The preset knob locks after the dots (LEDs) around the knob have flashed 3 times.

Hold down the preset knob for 5 seconds or more in locked state to unlock the knob.

The preset knob unlocks after the dots (LEDs) around the knob have flashed 3 times.

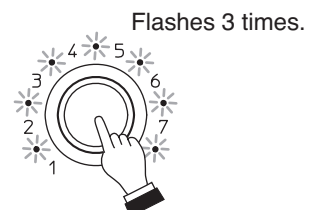

Hold down for 5 seconds or more.

8. PC CONNECTIONS

8.1. Connections

Connect the PC to the unit's network connection terminal via a switching hub.
Use a straight through cable for connection.

Notes

- To enable communications between the PC and the unit, set the unit's network setting needs to be set on the PC. For communication settings, refer to the software setting instruction manual included in the supplied CD.
- The PC can communicate with only one unit at a time.

[Memo]

We have confirmed that the PC having the specifications below can communicate with up to 30 units at a time.

Processor: Intel® Pentium® M Processor/1.6 GHz

Memory: 512 MB RAM

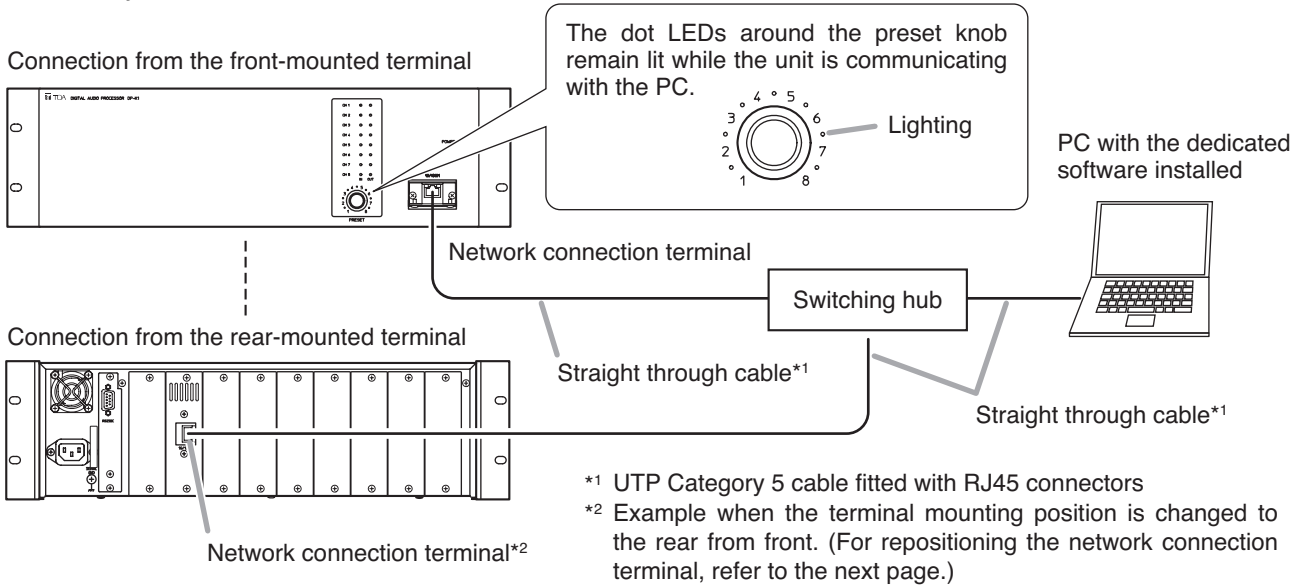

*1 UTP Category 5 cable fitted with RJ45 connectors

*2 Example when the terminal mounting position is changed to the rear from front. (For repositioning the network connection terminal, refer to the next page.)

Tip

You may connect the DP-K1 to the PC directly by using a cross cable.

Depending on the PC settings, however, this direct connection may not be allowed. In such cases, make connections via a switching hub as shown above.

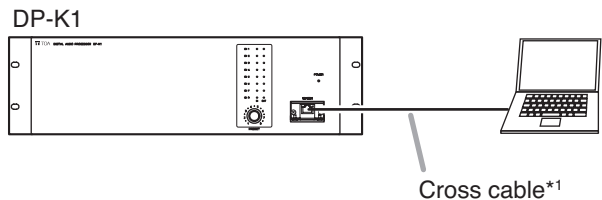

[Reference: LAN cable wiring diagrams]

The LAN wiring standard of ANSI/TIA/EIA-568-B specifies 2 wiring standards T568A and T568B for straight through cable wirings.

• RJ45 pin No.

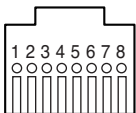

• T568A Straight through cable wiring

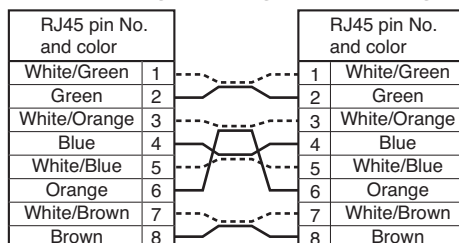

• Cross cable wiring (T568A base)

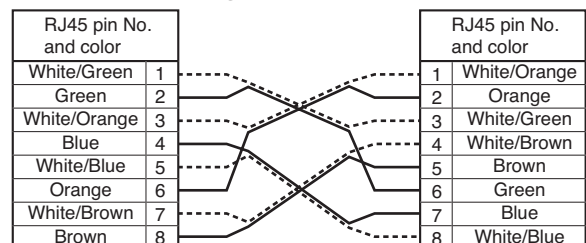

• T568B Straight through cable wiring

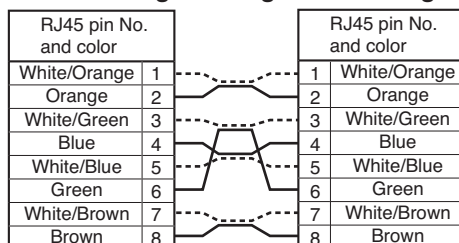

• Cross cable wiring (T568B base)

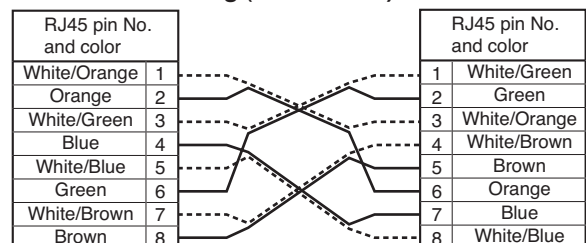

8.2. Repositioning the Network Connection Terminal

⚠ WARNING

These servicing instructions are for use by qualified personnel only. To avoid electric shock, do not perform any servicing other than that contained in the operating instructions unless you are qualified to do so. Refer all servicing to qualified service personnel.

Step 1. Plug out the power cord from the AC wall outlet.

⚠ WARNING Never do this work with the power cord connected to the outlet, as doing so may cause electric shock.

Step 2. Remove 6 screws and washers on both sides of the unit to detach the case.

Step 3. Detach a harness connected to the Ethernet PC board and Main PC board.

Note

The removed harness is not used.

Step 4. Connect a 9P connector taped to the Main PCB to the CN701 connector after taking it off.

Step 5. Detach the pocket cover from the front panel.

Step 6. Remove 2 screws to detach the Ethernet PC board from the front chassis.

Note

The removed screws are used in Step 11.

Step 7. Reattach the removed packet cover.

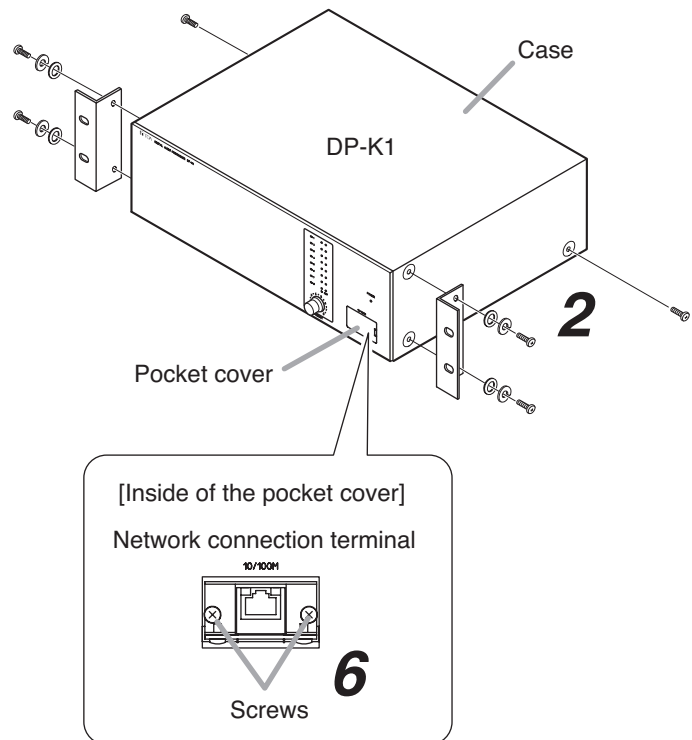

Interior with the case removed

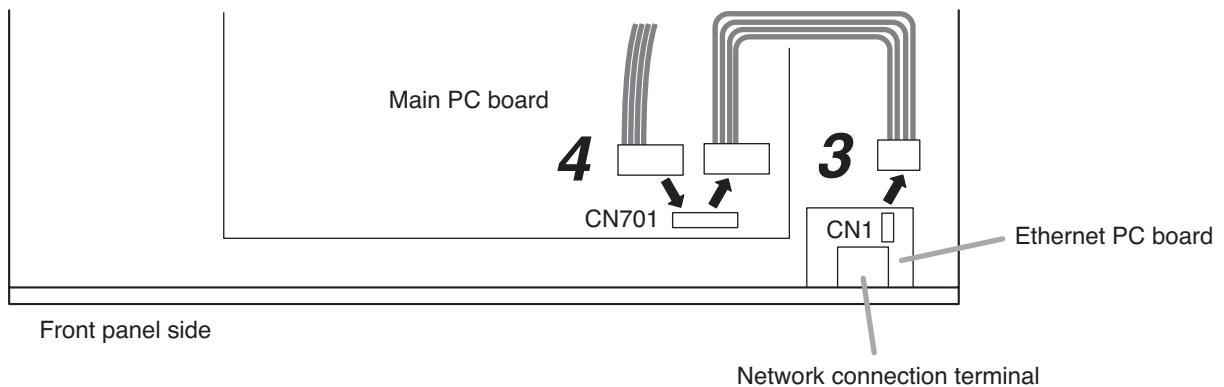

Step 8. Cut the cable tie on the center of the rear-mounted network connection terminal panel.

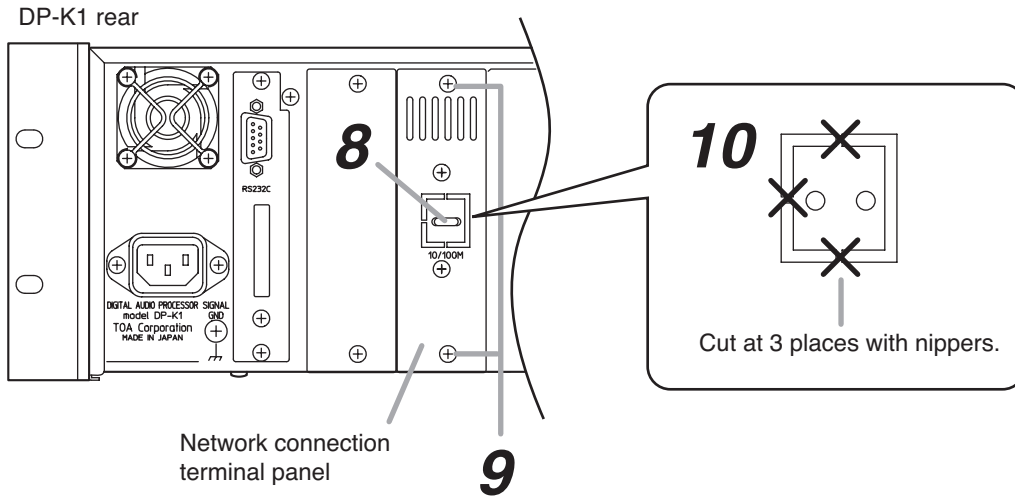

Step 9. Remove 2 screws to detach the network connection terminal panel.

Note

The removed screws are used in Step 13.

Step 10. Detach the harness from the backside of the panel, then cut the knockout hole on the center of the panel using nippers.

Step 11. Mount the Ethernet PC board to the backside of the network connection terminal panel. Use 2 screws removed in Step 6.

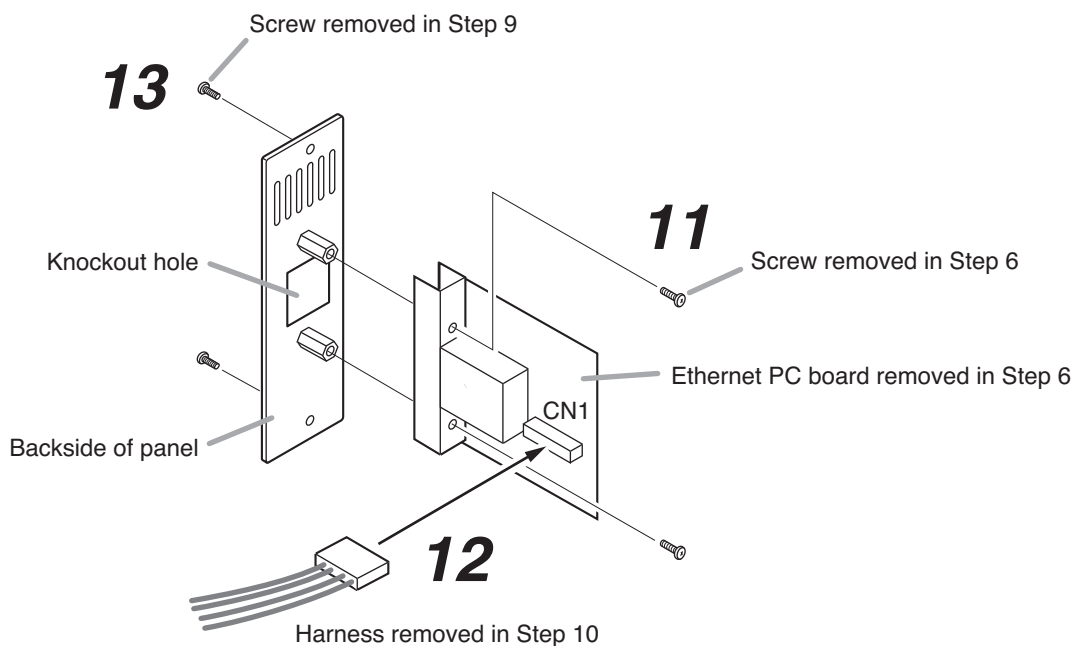

Step 12. Connect the 5P connector of the harness removed in Step 10 to the CN1 on the Ethernet PC board.

Step 13. Reattach the removed network connection terminal panel.

Step 14. Replace the removed case and rack mounting brackets.

9. RESTORING FACTORY DEFAULT SETTING

Step 1. Switch off the unit's power.

Step 2. Switch on the power while holding down the preset knob.
All input channel indicators light up.

Step 3. After 5 seconds, release the preset knob when the indicators extinguish and all output channel indicators light up.
The internal parameter is restored to the factory default setting.

Note

The network settings are not initialized.

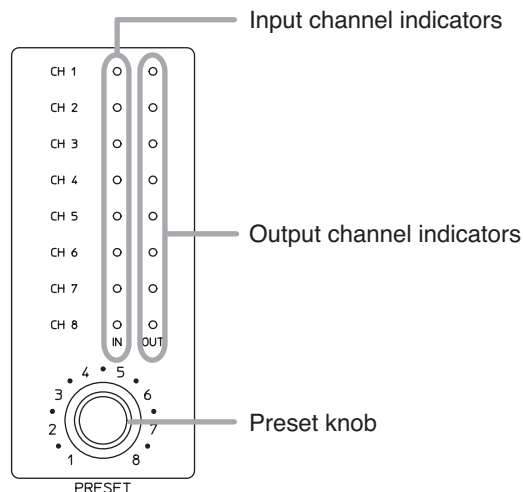

10. RACK MOUNTING

Mount the unit in an equipment rack using the supplied rack-mounting screws.

Note

The supplied rack mounting screws are special screws for the TOA equipment rack. They cannot be used for other racks.

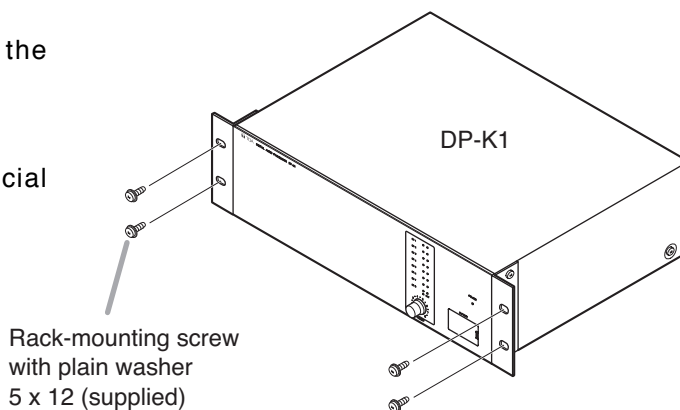

Cautions

- Install the unit as far as possible away from amplifiers or other equipment that generate heat.
- The socket-outlet shall be installed near the equipment and the plug (disconnecting device) shall be easily accessible.
- When installing the unit in an equipment rack, pay attention not to block the ventilation slots on the unit's bottom. It is recommended that a Perforated panel of over 1-unit in size be mounted directly below the unit as shown below.

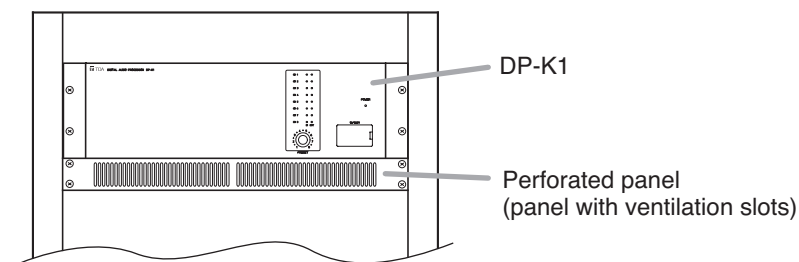

11. CONNECTIONS

11.1. Connection Example

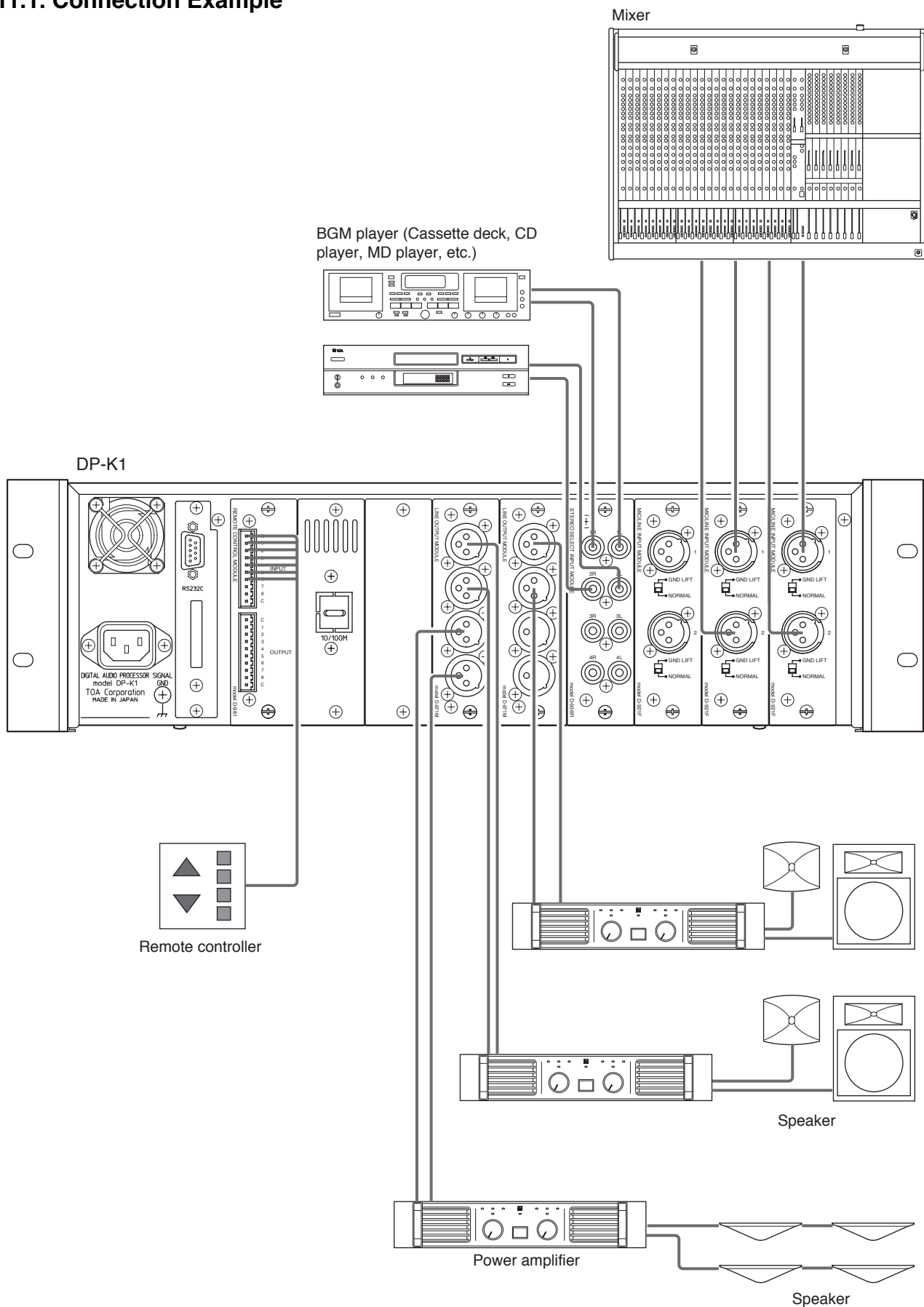

11.2. Removable Terminal Plug Connection

Cautions

- Be sure to use shielded cables for audio signal lines.
- Avoid soldering stranded or shielded cable, as contact resistance may increase when the cable is tightened and the solder is crushed, possibly resulting in an excessive rise in joint temperatures.

Cable end treatment

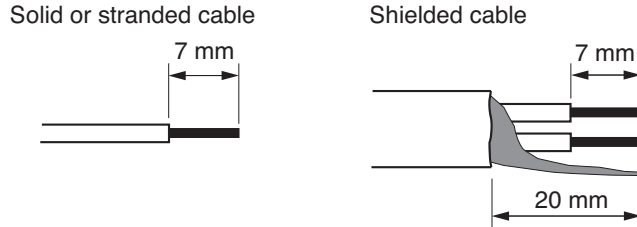

Connector connections

Step 1. Detach the unit's rear-mounted input/output connector (removable terminal plug) from the unit.

Step 2. Loosen the terminal screw, then insert the cable.

Step 3. Retighten the terminal screw. (Pull on the cable to ensure it is securely connected.)

Step 4. Remount the input/output connector to the unit.

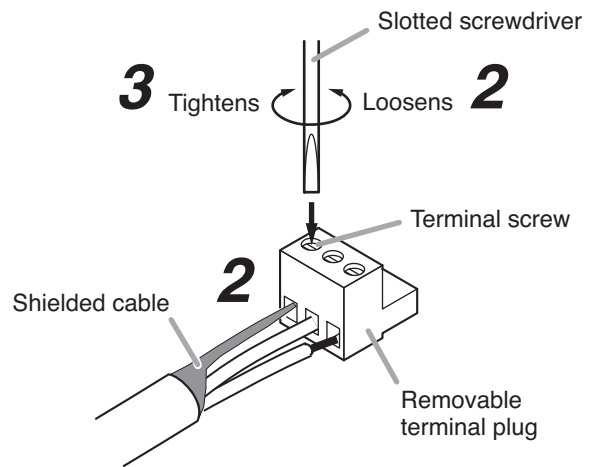

Tip

Recommended slotted screwdriver type: Screwdriver with blade that is 3 mm in width



11.3. Ferrite Cable Clamp Attachment (For D-972AE only)

To reduce electromagnetic noise, place the supplied ferrite clamp over each digital output cable when making a cable connection to the D-972AE Digital Output Module.

Install one ferrite clamp per digital output cable.

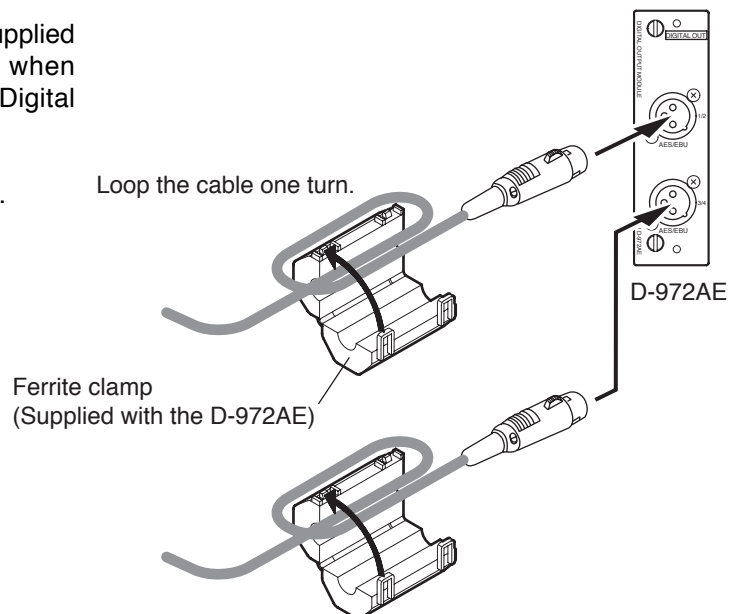

12. BLOCK DIAGRAM

Microphone/Line Input Module (D-921F or D-921E)

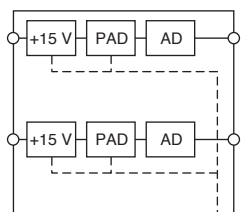

Microphone/Line Input Module (D-922F or D-922E)

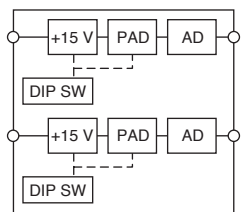

Stereo Input Module (D-936R)

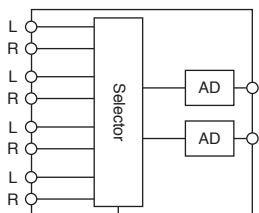

Digital Input Module (D-923AE)

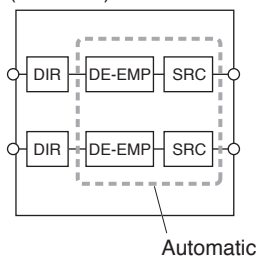

Digital Input Module (D-937SP)

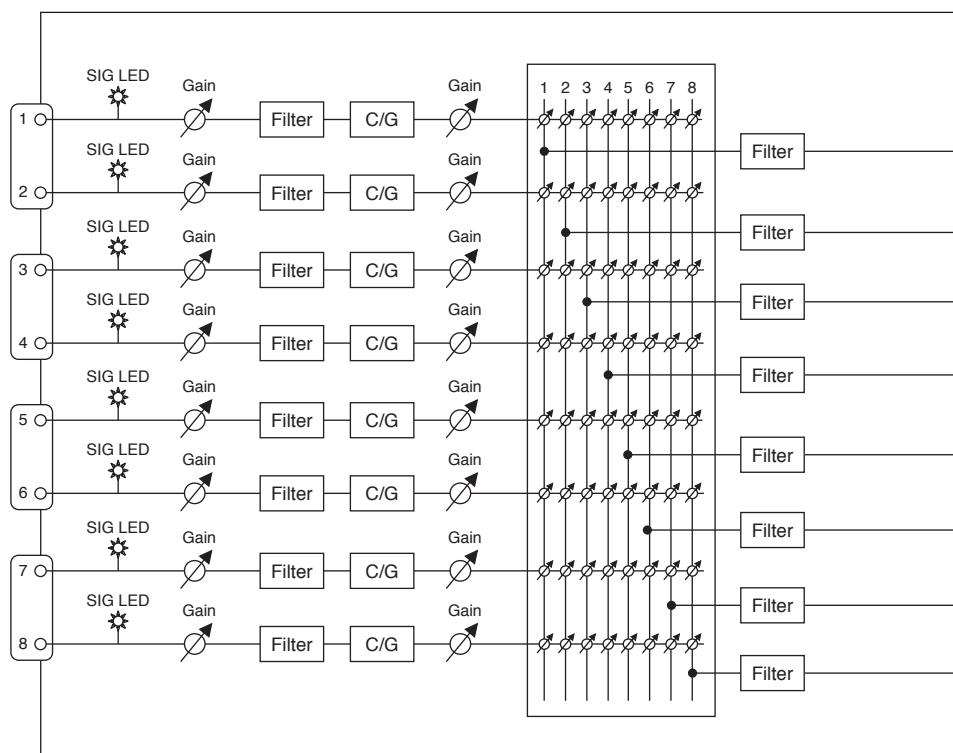
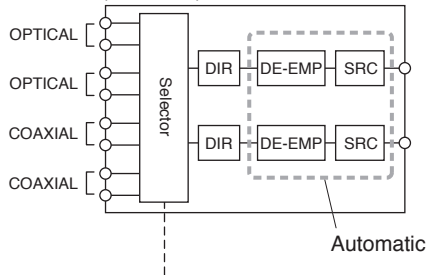

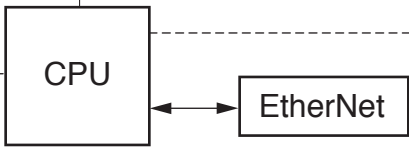
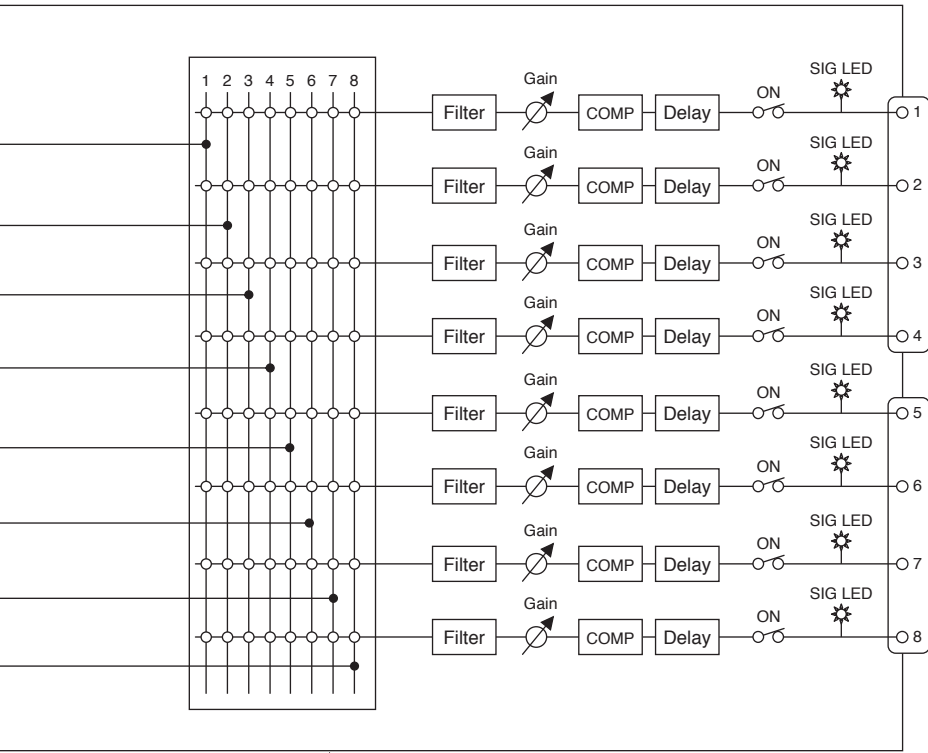

Line Output Module (D-971M or D-971E)

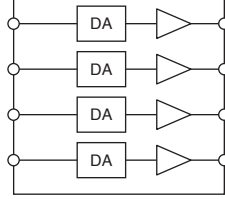

Line Output Module (D-971R)

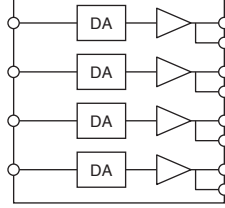

Digital Output Module (D-972AE)

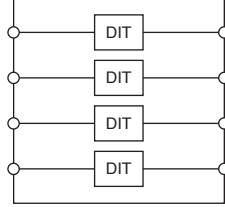

Digital Output Module (D-961SP)

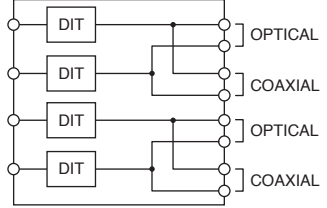

Remote Control Module (D-981)

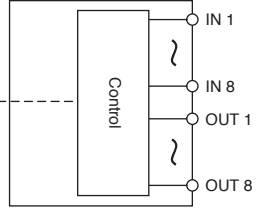

Remote Control Module (D-983)

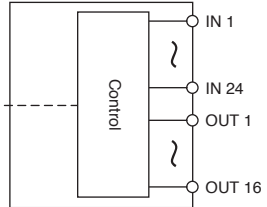

13. LEVEL DIAGRAMS

13.1. Analog Input/Output

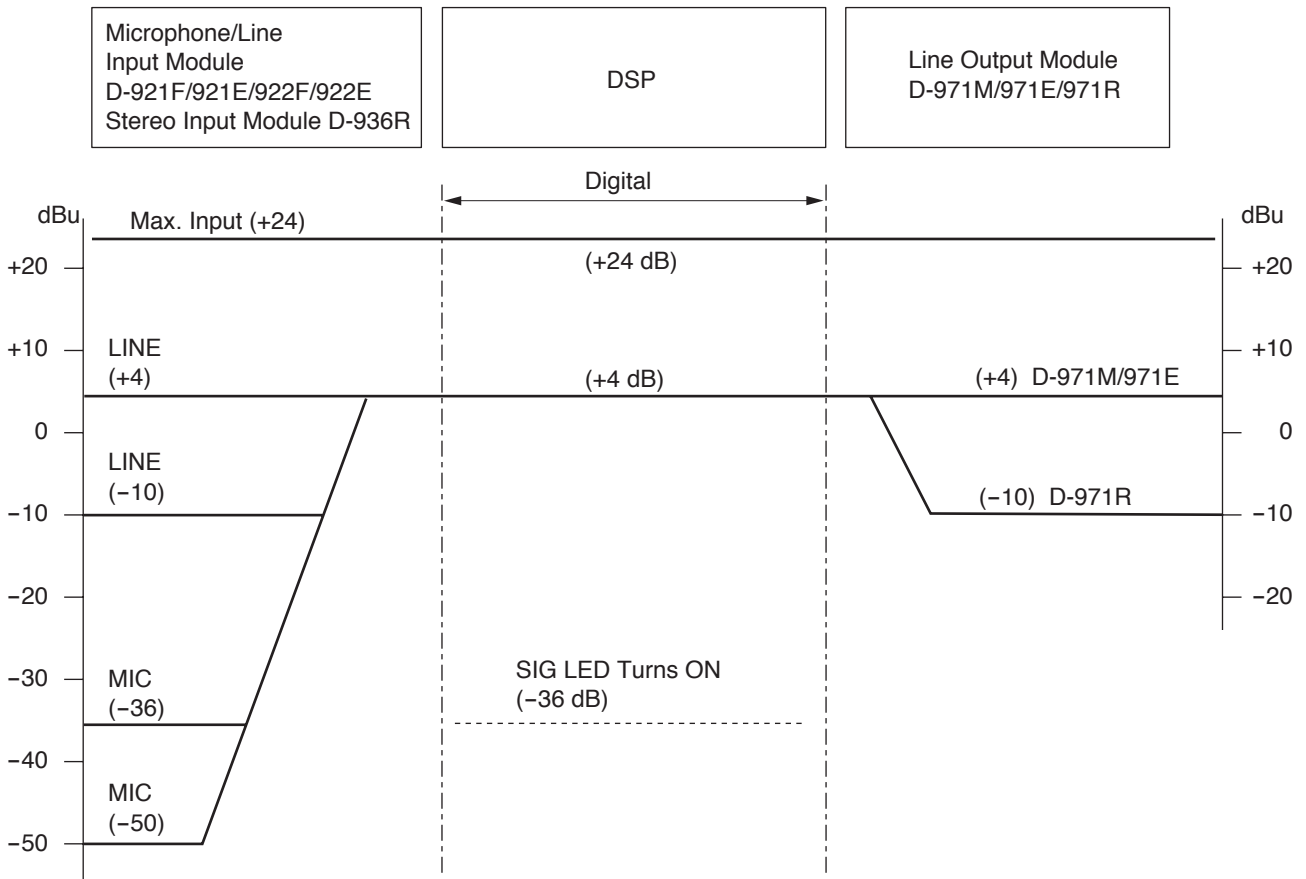

13.2. Digital Input/Output

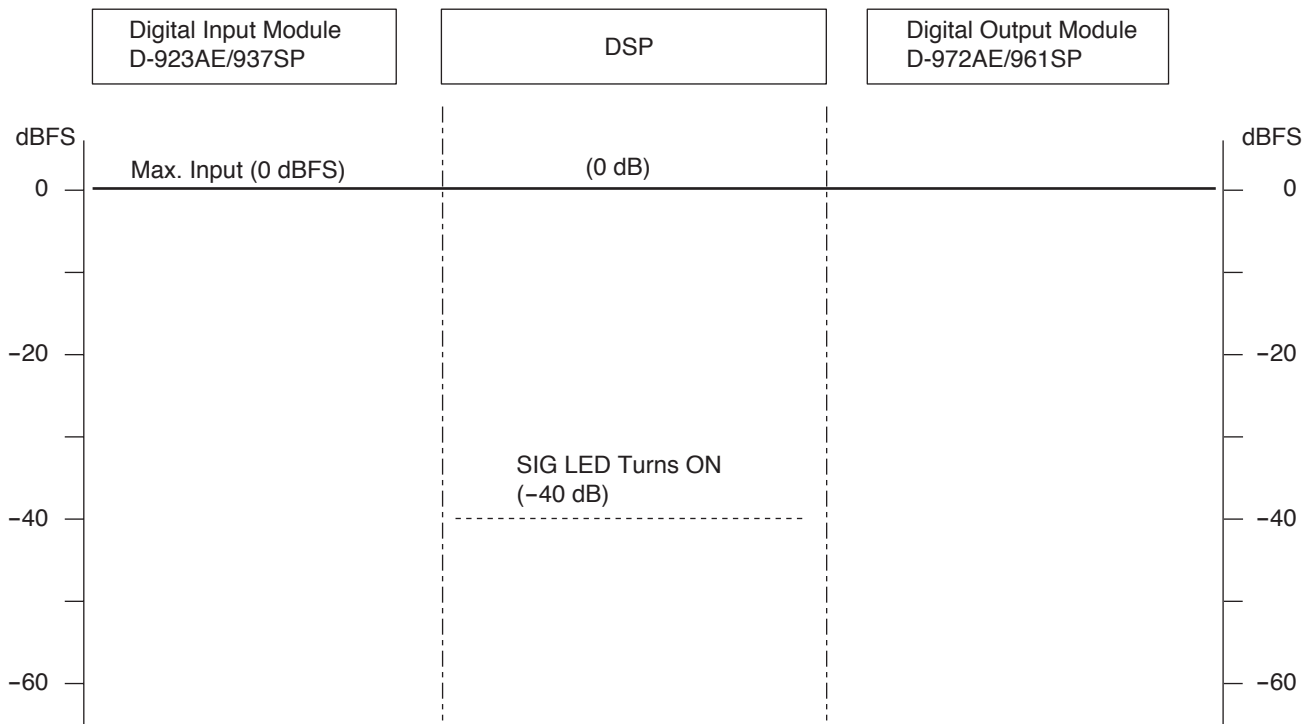

14. SPECIFICATIONS

14.1. DP-K1 Digital Audio Processor

Power Source	CE version: 230 V AC, 50/60 Hz, CU version: 100 – 120 V AC, 50/60 Hz	
Power Consumption	CE version: 40 W (450 mA), CU version: 40 W (750 mA)	
Frequency Response	20 – 20,000 Hz, ± 1 dB (± 4 dB* input)	
Input	Max. 8 channels, modular construction (modules optional)	
Output	Max. 8 channels, modular construction (modules optional)	
IO Configuration	2-IN/4-OUT, 2-IN/8-OUT, 4-IN/4-OUT, 4-IN/8-OUT, 6-IN/4-OUT, 6-IN/8-OUT, 8-IN/4-OUT, 8-IN/8-OUT	
Signal Processing	Automatic Resonance Control Function	Parametric equalizer: 20 – 20,000 Hz, ± 12 dB, Q: 0.267 – 69.249
	Level Control	$-\infty$ to +12 dB (0.5 dB steps), with polarity selector
	Equalizer/Filter	Parametric equalizer: 20 – 20,000 Hz, ± 12 dB, Q: 0.267 – 69.249 Filtering: High-pass filter 20 – 20,000 Hz, 6 dB/oct, 12 dB/oct Low pass filter 20 – 20,000 Hz, 6 dB/oct, 12 dB/oct Notch filter 20 – 20,000 Hz, Q: 8.651 – 69.249 All-pass filter 20 – 20,000 Hz, Q: 0.267 – 69.249 High shelving filter 6 – 20 kHz, ± 12 dB Low shelving filter 20 – 500 Hz, ± 12 dB Horn equalizer 20 kHz, 0 to +18 dB (0.5 dB steps) Crossover filter: 20 – 20,000 Hz, 6 dB/oct, 12 dB/oct, 18 dB/oct, 24 dB/oct
	Compressor	Threshold: –16 to +24 dB* (1 dB steps) Ratio: 1:1, 2:1, 3:1, 4:1, 8:1, 12:1, 20:1, ∞ :1 Attack time: 0.2 – 100 ms Release time: 10 ms – 5 s
	Noise Gate	Threshold: $-\infty$ to –26 dB* (1 dB steps) Attack time: 0.1 – 100 ms Release time: 20 ms – 5 s
	Delay	Delay time: 0 – 682.0 ms (0.021 ms steps)
Matrix	8 x 8 Level control: $-\infty$ to 0 dB (1 dB steps), with polarity selector	
Preset Memory	8	
Auxiliary Function	Key lock function	
Setting Software	OS: Windows 2000, Windows XP Control system: 10 BASE-T/100 BASE-TX, Auto-negotiation, RJ45 connector	
Front Panel Section	Preset knob: 1 Input channel indicator: Green LED Output channel indicator: Green LED	
Module Slot (Rear Panel)	Input module slot: 4 Output module slot: 2 Remote control module slot: 1	
Operating Temperature	+5 to +40 °C	
Finish	Panel: Aluminum, hair-line finish, black Others: Pre-coated steel plate, black, 30% gloss	
Dimensions	482.6 (w) x 132.6 (h) x 320 (d) mm (excluding projection)	
Weight	7.4 kg	

* 0 dB = 0.775 V

Notes

- The design and specifications are subject to change without notice for improvement.
- Windows is a trademark of Microsoft Corporation.

• Accessories

CD (Setting software, setting instructions)	1	Rack mounting bracket (preinstalled on the unit) ..	2
Power cord (2 m)	1	Module mounting screw (spare)	4
Rack mounting screw with plain washer (5 x 12) ..	4	Blank panel (preinstalled on the module slot)	8

14.2. D-921F Microphone/Line Input Module (Optional)

Input	2 channels, Mic/Line changeable Mic: -50/-36 dB*, 4.7 kΩ, electronically-balanced, equivalent to XLR-3-31 type Line: -10/+4 dB*, 10 kΩ, electronically-balanced, equivalent to XLR-3-31 type Phantom power supply (+15 V, can be used when set for the microphone) Ground lift switch
A/D Converter	24 bits
Sampling Frequency	48 kHz
Frequency Response	20 – 20,000 Hz, ±1 dB (+4 dB* input)
Dynamic Range	Over 100dB (IHF-A weighted) (+4 dB* input)
Total Harmonic Distortion	Under 0.05% (+4 dB* input)
Finish	Panel: Pre-coated steel plate, black (30% glossy)
Dimensions	35 (w) x 119.5 (h) x 178.4 (d) mm
Weight	150 g

14.3. D-921E Microphone/Line Input Module (Optional)

Input	2 channels, Mic/Line changeable Mic: -50/-36 dB*, 4.7 kΩ, electronically-balanced, 3-pin removable terminal block Line: -10/+4 dB*, 10 kΩ, electronically-balanced, 3-pin removable terminal block Phantom power supply (+15 V, can be used when set for the microphone) Ground lift switch
A/D Converter	24 bits
Sampling Frequency	48 kHz
Frequency Response	20 – 20,000 Hz, ±1 dB (+4 dB* input)
Dynamic Range	Over 100dB (IHF-A weighted) (+4 dB* input)
Total Harmonic Distortion	Under 0.05% (+4 dB* input)
Finish	Panel: Pre-coated steel plate, black (30% glossy)
Dimensions	35 (w) x 119.5 (h) x 178.4 (d) mm
Weight	140 g

• **Accessories**

3-pin removable terminal plug (preinstalled on the unit) 2

14.4. D-922F Microphone/Line Input Module (Optional)

Input	2 channels, -50/-36/-10/+4 dB* (Selectable with the DIP switch), 4.7 kΩ, electronically-balanced, equivalent to XLR-3-31 type Phantom power supply (+15 V, can be set with the DIP switch) Ground lift switch (can be set with the DIP switch)
A/D Converter	20 bits
Sampling Frequency	48 kHz
Frequency Response	20 – 20,000 Hz, ±1 dB (+4 dB* input)
Dynamic Range	Over 85 dB (IHF-A weighted) (+4 dB* input)
Total Harmonic Distortion	Under 0.2% (+4 dB* input)
Finish	Panel: Pre-coated steel plate, black (30% glossy)
Dimensions	35 (w) x 119.5 (h) x 178.4 (d) mm
Weight	135 g

* 0 dB = 0.775 V

Note: The design and specifications are subject to change without notice for improvement.

14.5. D-922E Microphone/Line Input Module (Optional)

Input	2 channels, -50/-36/-10/+4 dB* (Selectable with the DIP switch), 4.7 k Ω , electronically-balanced, 3-pin removable terminal block Phantom power supply (+15 V, can be set with the DIP switch) Ground lift switch (can be set with the DIP switch)
A/D Converter	20 bits
Sampling Frequency	48 kHz
Frequency Response	20 – 20,000 Hz, ± 1 dB (+4 dB* input)
Dynamic Range	Over 85 dB (IHF-A weighted) (+4 dB* input)
Total Harmonic Distortion	Under 0.2% (+4 dB* input)
Finish	Panel: Pre-coated steel plate, black (30% glossy)
Dimensions	35 (w) x 119.5 (h) x 178.4 (d) mm
Weight	125 g

• **Accessories**

3-pin removable terminal plug (preinstalled on the unit) 2

14.6. D-936R Stereo Input Module (Optional)

Input	4 stereo inputs (Selection of 1 stereo or mixing or all 4 stereo inputs) -10 dB*, 10 k Ω , RCA pin jack
A/D Converter	24 bits
Sampling Frequency	48 kHz
Frequency Response	20 – 20,000 Hz, ± 1 dB (+4 dB* input)
Dynamic Range	Over 100dB (IHF-A weighted)
Total Harmonic Distortion	Under 0.05%
Finish	Panel: Pre-coated steel plate, black (30% glossy)
Dimensions	35 (w) x 119.5 (h) x 178.4 (d) mm
Weight	145 g

14.7. D-923AE Digital Input Module (Optional)

Input	2 channels, 2.0 – 7.0 V (p-p), 110 Ω , equivalent to XLR-3-31
Applicable Format	AES/EBU (2 channel multiplexed)
Sampling Frequency	32 – 48 kHz
Finish	Panel: Pre-coated steel plate, black (30% glossy)
Dimensions	35 (w) x 119.5 (h) x 178.4 (d) mm
Weight	130 g

14.8. D-937SP Digital Input Module (Optional)

Input	Stereo 1 channel (Selectable one of 4 inputs) 0.5 V (p-p), 75 Ω , Coaxial RCA pin jack x 2 Square optical connector x 2
Applicable Format	S/PDIF (2 channel multiplexed)
Sampling Frequency	32 – 48 kHz
Finish	Panel: Pre-coated steel plate, black (30% glossy)
Dimensions	35 (w) x 119.5 (h) x 178.4 (d) mm
Weight	130 g

* 0 dB = 0.775 V

Note: The design and specifications are subject to change without notice for improvement.

14.9. D-971M Line Output Module (Optional)

Output	4 channels, +4 dB*, adaptable load of over 600 Ω, electronically-balanced, equivalent to XLR-3-32 type
D/A Converter	24 bits
Sampling Frequency	48 kHz
Frequency Response	20 – 20,000 Hz, ±1 dB
Dynamic Range	Over 100dB (IHF-A weighted)
Total Harmonic Distortion	Under 0.05%
Finish	Panel: Pre-coated steel plate, black (30% glossy)
Dimensions	35 (w) x 119.5 (h) x 178.4 (d) mm
Weight	165 g

14.10. D-971E Line Output Module (Optional)

Output	4 channels, +4 dB*, adaptable load of over 600 Ω, electronically-balanced, 3-pin removable terminal block
D/A Converter	24 bits
Sampling Frequency	48 kHz
Frequency Response	20 – 20,000 Hz, ±1 dB
Dynamic Range	Over 100dB (IHF-A weighted)
Total Harmonic Distortion	Under 0.05%
Finish	Panel: Pre-coated steel plate, black (30% glossy)
Dimensions	35 (w) x 119.5 (h) x 178.4 (d) mm
Weight	140 g

• **Accessories**

3-pin removable terminal plug (preinstalled on the unit) 2

14.11. D-971R Line Output Module (Optional)

Output	4 channels (2 outputs for each channel), –10 dB*, adaptable load of over 600 Ω, RCA pin jack
D/A Converter	24 bits
Sampling Frequency	48 kHz
Frequency Response	20 – 20,000 Hz, ±1 dB
Dynamic Range	Over 100dB (IHF-A weighted)
Total Harmonic Distortion	Under 0.05%
Finish	Panel: Pre-coated steel plate, black (30% glossy)
Dimensions	35 (w) x 119.5 (h) x 178.4 (d) mm
Weight	150 g

14.12. D-972AE Digital Output Module (Optional)

Output	4 channels, 5.0 V (p-p), 110 Ω, equivalent to XLR-3-32
Applicable Format	AES/EBU (2 channel multiplexed)
Sampling Frequency	48 kHz
Finish	Panel: Pre-coated steel plate, black (30% glossy)
Dimensions	35 (w) x 119.5 (h) x 178.4 (d) mm
Weight	130 g

• **Accessories**

Ferrite clamp 2

* 0 dB = 0.775 V

Note: The design and specifications are subject to change without notice for improvement.

14.13. D-961SP Digital Output Module (Optional)

Output	Stereo 2 channels (with splitter, each pair of optical output and coaxial output in parallel), 0.5 V (p-p), 75 Ω, Coaxial RCA jack x 2 Square optical connector x 2
Applicable Format	S/PDIF (2 channel multiplexed)
Sampling Frequency	48 kHz
Finish	Panel: Pre-coated steel plate, black (30% glossy)
Dimensions	35 (w) x 119.5 (h) x 178.4 (d) mm
Weight	130 g

14.14. D-981 Remote Control Module (Optional)

Contact Input	COM + Terminals 1 – 8: Open voltage: 5 V DC, short-circuit: 5 mA, 10-pin removable terminal block
Control	Preset Memory Selection Any preset memory can be recalled. Control method: No-voltage make of over 100 ms or no-voltage make single pulse of over 100 ms
	Volume Volume can be turned UP or DOWN for any input and output channels. Control system: 1 step variation for no-voltage make single pulse of over 100 ms 1 step continuous operation for every 70 ms for no-voltage make of over 100 ms. Can be reset when at break. Variable range: $-\infty$ dB to 0 dB
	Mute Any output channels can be turned ON and OFF. Control method: No-voltage make of over 100 ms or no-voltage make single pulse of over 100 ms
Contact Output	COM + Terminals 1 – 8: No-voltage make contact input, contact capacity: 24 V DC, 100 mA removable terminal block
Finish	Panel: Pre-coated steel plate, black (30% glossy)
Dimensions	35 (w) x 119.5 (h) x 178.4 (d) mm
Weight	125 g

• Accessories

10-pin removable terminal plug (preinstalled on the unit) 2

Note: The design and specifications are subject to change without notice for improvement.

14.15. D-983 Remote Control Module (Optional)

Contact Input	COM + Terminals 1 – 24: Open voltage 5 V DC, short-circuit current 5 mA, RJ45 connector x 4
Control	Preset Memory Selection Any preset memory can be recalled. Control method: No-voltage make of over 100 ms or no-voltage make single pulse of over 100 ms
	Volume Control Any input/output channel volume can be turned UP or DOWN. Control method: 1 step variation with no-voltage make single pulse of over 100 ms 1 step continuous operation for every 70 ms for no-voltage make of over 100 ms. Can be reset when at break. Variable range: $-\infty$ dB to 0 dB
	Mute Any output channel can be turned ON and OFF. Control method: No-voltage make of over 100 ms or no-voltage make single pulse of over 100 ms
Contact Output	COM + Terminals 1 – 16: No-voltage make contact, contact capacity: 24 V DC, 100 mA, RJ45 connector x 4
Finish	Panel: Pre-coated steel plate, black (30% glossy)
Dimensions	35 (w) x 119.5 (h) x 178.4 (d) mm
Weight	170 g

Note: The design and specifications are subject to change without notice for improvement.