

DESCRIPTION

The Plane Wave Speaker features a flat speaker system equipped with plane wave units, realizing a narrow directivity pattern by radiating plane wave sound. Since the Plane Wave Speaker can deliver sound output toward a limited target area, it is suited for use in locations such as station platforms and escalator areas that require information announcements to be broadcast, and in such spaces as museums and art galleries where the reverberation time is long. A double-sided radiation type radiates sound both backward and forward.

SPECIFICATIONS

Type of Radiation	Double-sided radiation Front (The side with TOA logo affixed): Positive pressure wave, Rear: Negative pressure wave
Rated Input	30 W
Rated Impedance	High impedance 100 V line: 330 Ω (30 W), 670 Ω (15 W), 1 kΩ (10 W), 2 kΩ (5 W) High impedance 70 V line: 170 Ω (30 W), 330 Ω (15 W), 670 Ω (7.5 W), 1 kΩ (5 W), 2 kΩ (2.5 W)
Sensitivity	86 dB (1 W, 1 m equivalent measured at 4 m, 1 - 10 kHz) 86 dB (1 W, measured at 1 m, 1 - 10 kHz) (Beam tilting: FLAT, High pass filter: OFF)
Frequency Response	300 Hz - 17.5 kHz (Beam tilting: FLAT, High pass filter: OFF)
Directivity Angle	Horizontal: 38° (2 kHz, 1/3 octave band), Vertical: 75° (2 kHz, 1/3 octave band)
Speaker Unit	Plane wave unit (152 × 214 mm (5.98" × 8.43")) × 2
Setting Switch	Beam tilting (radiation direction) FLAT: 0° downward/DOWNWARD: 5° downward High pass filter (450 Hz, -12 dB/oct) : OFF/ON
Speaker Cord	φ9 mm (0.35"), 6-core cabtyre cable, 2 m (6.56 ft)
Water Protection	IPX4
Operating Temperature	-10 °C to +50 °C (14 °F to 122 °F)
Finish	Enclosure, Punched net, and Mounting bracket: Stainless, light ivory, semi-gloss, paint
Dimensions	524 (W) × 355 (H) × 60 (D) mm (20.63" × 13.98" × 2.36") (including mounting bracket)
Weight	7.3 kg (16.09 lb) (including mounting bracket)

Note: Do not install the unit where it is likely to be corroded in such places as indoor pools, bathrooms, or seaside.

APPEARANCE

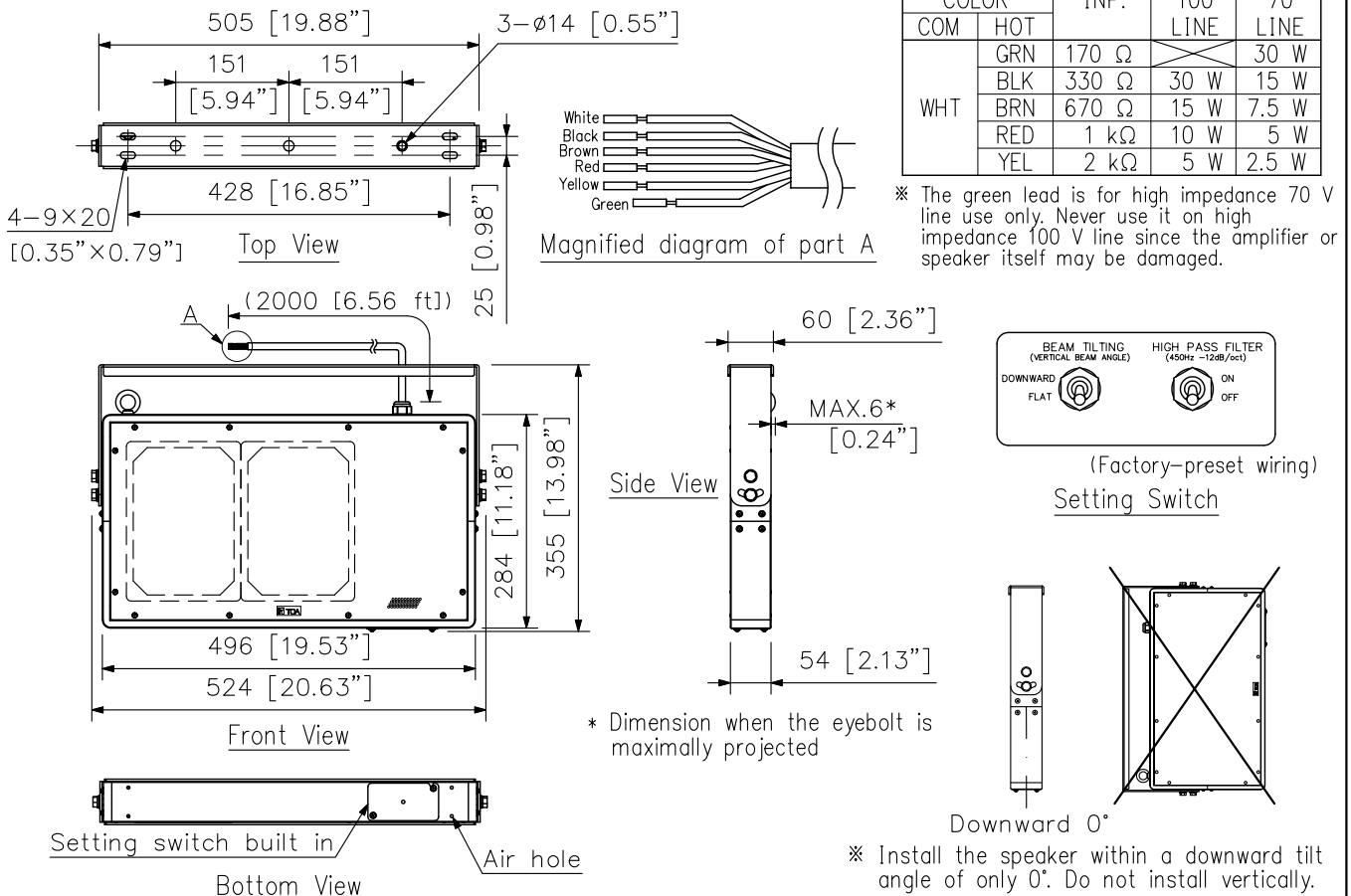

UNIT:mm SCALE:1/10

Note: Numerical values in parentheses are for reference only.