

■DESCRIPTION

The IP Intercom Exchange uses packet audio technology to permit connection of up to sixteen N-8000 Series stations. Hands-free conversation is possible between stations. Moreover, the exchange is equipped with a networking interface, allowing up to 192 exchanges to be connected over a network using additional IP intercom exchanges. The Exchange can be mounted in an EIA standard rack (1-unit size) or to a wall using the supplied bracket.

■SPECIFICATIONS

* 0 dB = 1 V

Power Source	120 V AC, 50/60 Hz
Power Consumption	50 W (at rated), 75 W (max.)
Interface Section for station	Number of lines: 16 lines Number of speech link: Internal: 1/External: 2 Type of Speech Path: Space sharing/Time Space sharing Transmission system: 2 wire 160 kbps echo canceller transmission system Signal Level: 0 dB* or less Transmission range: Max. 1500 m (∅0.65 mm, Loop resistance 170 Ω) Speech method: Simultaneous conversation by way of echo canceller (Hands-free), Simultaneous conversation by way of echo canceller or Half-duplex conversation by way of voice switch (Handset), PTT conversation Connector: Dedicated connector Wiring method: 1 set of twisted pair cable Feeding voltage/current: 48 V DC, Max. 70 mA
Paging Output	Station paging only
Network Section	Network I/F: 10BASE-T/100BASE-TX (Automatic-Negotiation) Network protocol: TCP/IP, UDP, HTTP, RTP, ARP, ICMP, IGMP Audio packet transmission system: Unicast, Multicast Number of paging destinations: Unicast (max. 16), Multicast (max. 191) Connector: RJ45 connector Voice sampling frequency: 16 kHz, 8 kHz (controllable on the software) Quantifying bit number: 16-bit Voice encoding method: Sub-band ADPCM, Cryptosystem Voice packet loss recovery: Silence insertion Audio delay time: 80 ms, 320 ms (controllable on the software)
Indication	Network LNK/ACT indication, Status lamp, Power-on indication lamp
Others	Firmware update function, System registration data entry hold facility, Time of day hold facility, Forced air cooling, Reset switch (front panel)
Setting Method	Rack, Desk, Surface mount
Operating Temperature	0 °C to +40 °C
Operating Humidity	90 %RH or less (no condensation)
Finish	Pre-coated steel plate, black, 30 % gloss
Dimensions	420 (W) x 44.3 (H) x 356 (D) mm
Weight	4.2 kg
Accessory	AC power cord (2 m)···1, CD (for PC setting, maintenance use)···1, Mini-clamp plug (2 pins)···20, Plastic foot···4, Screw for fitting plastic foot···4, Rack mounting bracket···2, Screw for rack mounting···4, Wall mounting bracket···2, Screw for mounting bracket···8, Screw for wall mounting···4

■ APPEARANCE

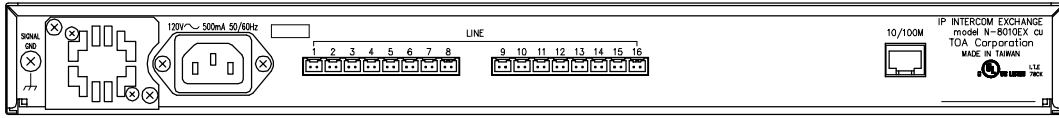

Rear View

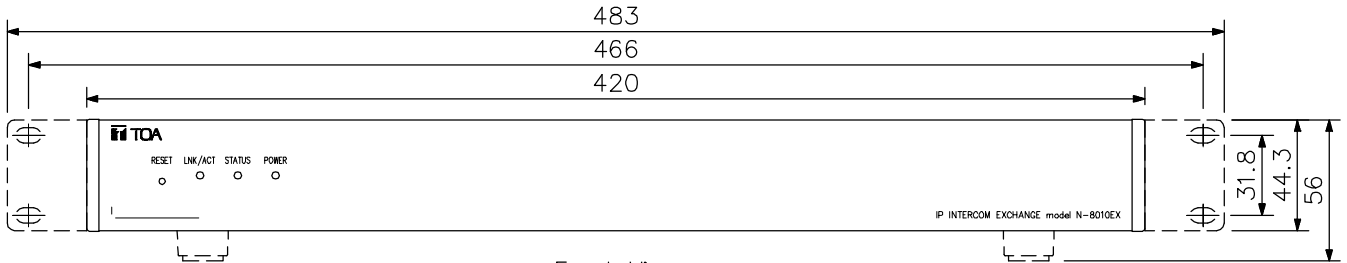

Front View

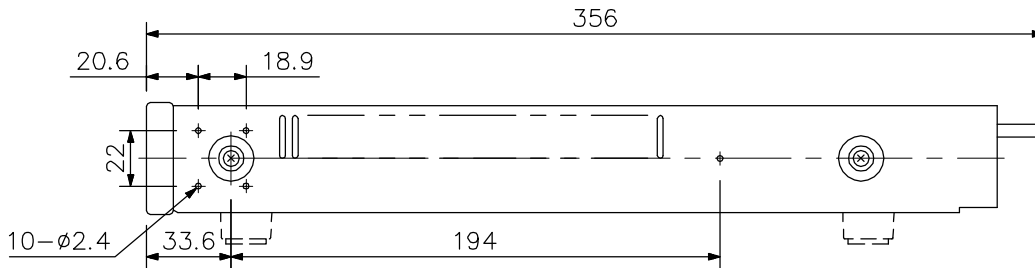

Side View

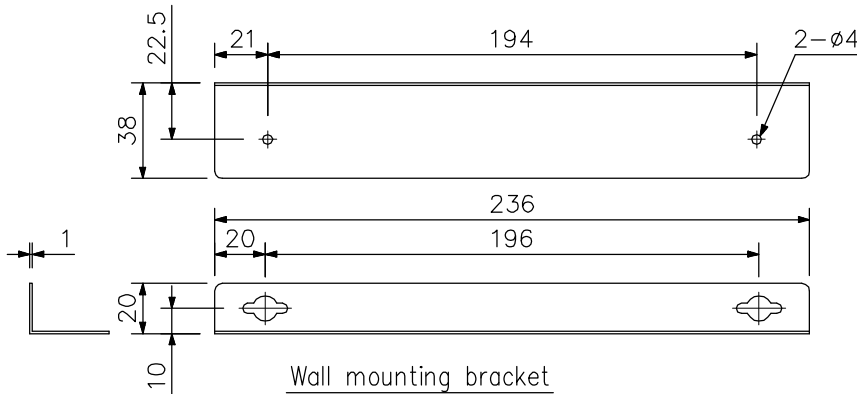

Wall mounting bracket
(accessory)

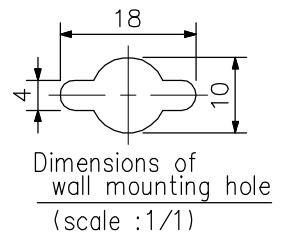

Dimensions of
wall mounting hole
(scale :1/1)

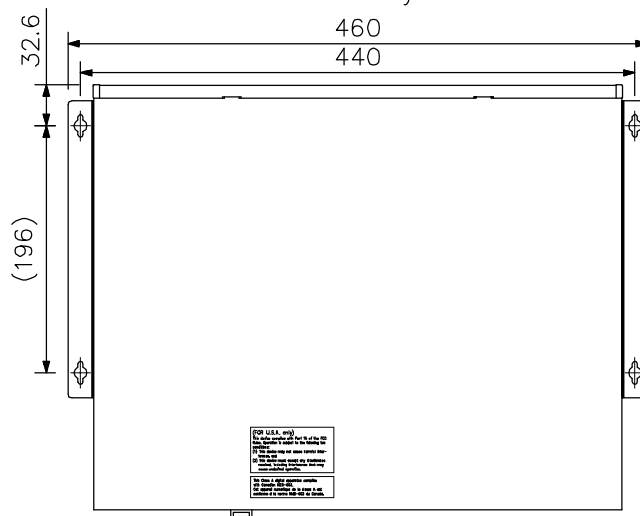

Wall mounting installation
(scale: 1/6)

UNIT: mm SCALE: 1/3