

### DESCRIPTION

TOA's F-605WP-L is a splash-proof two-way speaker system for low-impedance line, and is made up of a 30 cm woofer and a constant directivity horn with a driver.

### SPECIFICATIONS

Enclosure	Sealed enclosure
Power handling Capacity	Continuous pink noise: 120 W Continuous program: 360 W
Rated Impedance	8 Ω
Sound Pressure Level	98 dB (1 W, 1 m)
Frequency Response	80 - 20,000 Hz
Crossover Frequency	2,500 Hz
Speaker Component	Low frequency: 30 cm dia cone speaker High frequency: CD horn fitted with driver (60 ° horizontal × 40 ° vertical)
Connected Cable	Cable sent straight from internal speaker: 6.6 mm in diameter, Conductor cross section: 0.75 mm <sup>2</sup> , 2-core cable, 2 m
Finish	Enclosure: Polypropylene resin, ivory Front grill: Stainless steel, ivory, paint
Dimensions	552 (W) × 392 (H) × 250 (D) mm
Weight	16.5 kg
Usable Optional Mounting Bracket	Wall mounting: YS-600 Pole mounting: YS-600 + YS-60B (pole diameter: 90 - 340 mm)

Note: Exterior case is not treated with corrosion-free paint.

### APPEARANCE

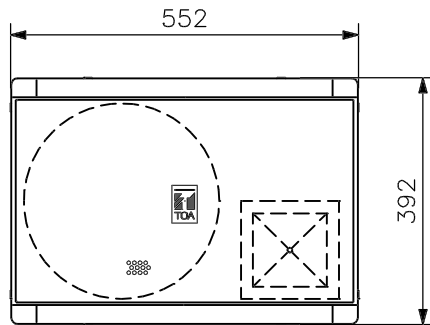

Front View

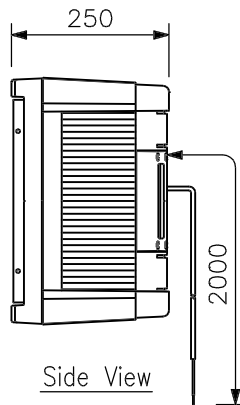

Side View

※ Installation angle (Downward angle)

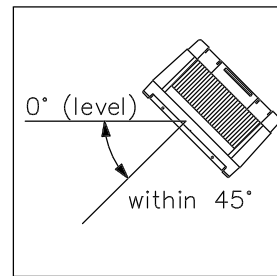

Install within above angle range.  
Do not install upside down.

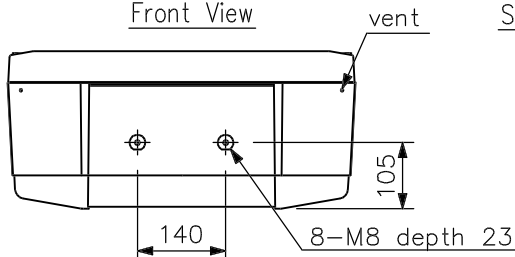

Bottom View

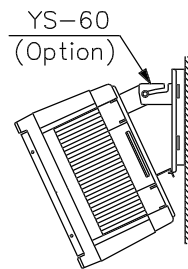

Wall Mounting

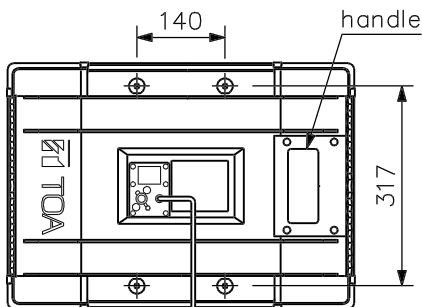

Black (+) White (-)

Rear View

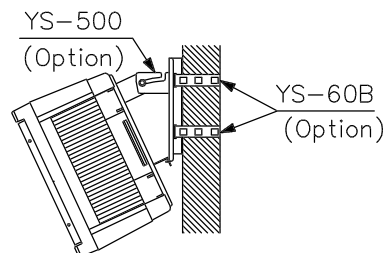

Pole Mounting

UNIT:mm SCALE:1/12