

TOA SPEAKER SYSTEM

2-WAY BASS REFLEX SPEAKER

F-605W/F-605G



F-605W



F-605G

DESCRIPTION

The TOA F-605W and F-605G are 2-way speaker systems with bass-reflex enclosures, housing a high-power 30cm (12") woofer, and a constant directivity (CD) horn with a high-efficiency driver. The CD horn assures a uniform, well-controlled dispersion pattern of 60° horizontal by 40° vertical within its specified frequency range. An extremely durable low-foam polypropylene resin enclosure provides superb acoustic characteristics. The F-605W and F-605G are designed for optimal efficiency, wide frequency response and lasting durability. And because of their convenient mobility and ease of installation, the F-605W and F-605G are well suited to a variety of applications. They are ideal for use as sound reinforcement equipment, and in live performance and recorded music systems where emphasis is placed on accurate sound reproduction and durability of equipment.

FEATURES

1. Extended frequency response provides smooth sound at all ranges.
2. High, 360 watts continuous program material power capacity.
3. 2-way bass-reflex speaker system.
4. Constant directivity horn with extremely well-controlled dispersion coverage pattern.
5. Highly efficient low-foam polypropylene resin compound enclosure with superb acoustic characteristics and durability.
6. Built-in overload protection circuitry.
7. Input panel with two push-in terminals and 1/4" phone jacks internally connected in parallel.
8. 1/4" phone jacks can be converted into XLR connectors.
9. Optional mounting brackets provide ease of installation.

APPEARANCE AND DIMENSIONAL DIAGRAM

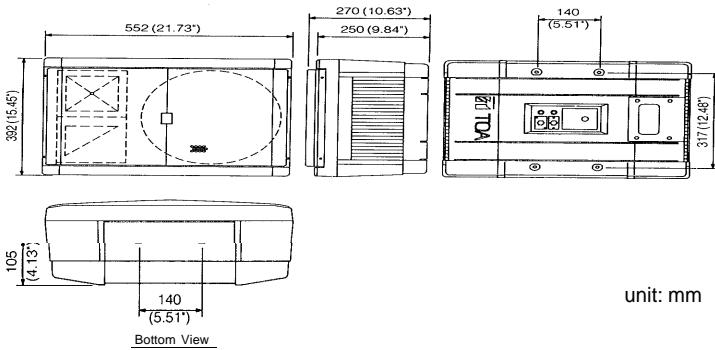

INPUT PANEL

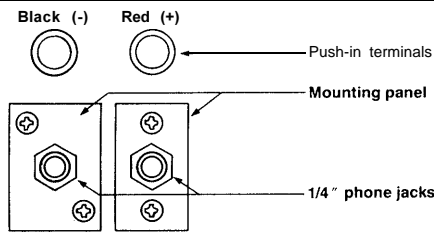

Push-in terminals and phone jacks (2 each) are all internally connected in parallel with each other. Two 1/4" phone jacks can be converted into XLR connectors by removing mounting panel and installing XLR connector.

PROTECTION CIRCUITRY

These speakers have individual protection circuitries that protect the woofer and the tweeter from the excessive input. (If the circuitry is activated, the input power to the woofer attenuates by 15 dB, with the tweeter cut off.)

HIGH FREQUENCY LEVEL CONTROL

Level control is provided for high frequency. Make the level setting according to the environmental conditions.

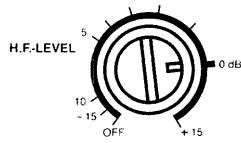

OPTIONS

Ceiling Mount Bracket

HY-30 (Black)/HY-30W (Ivory)

*Mounting angle is adjustable 360° horizontal and ±20° vertical.

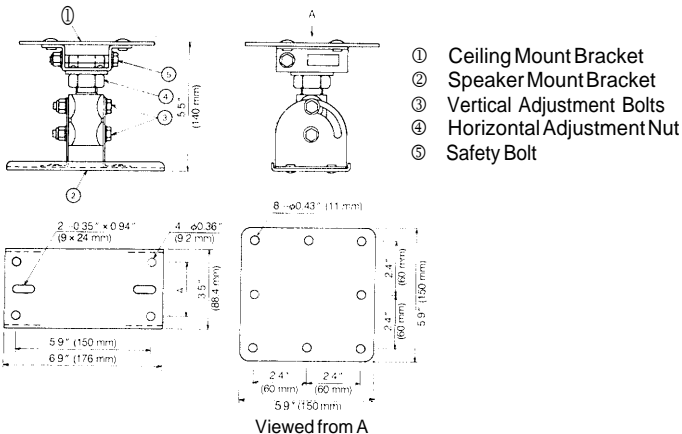

CHARACTERISTIC DIAGRAMS

Directivity Factor vs Frequency

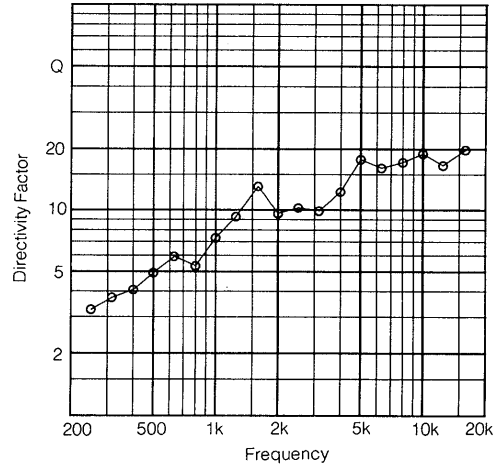

Bandwidth vs Frequency

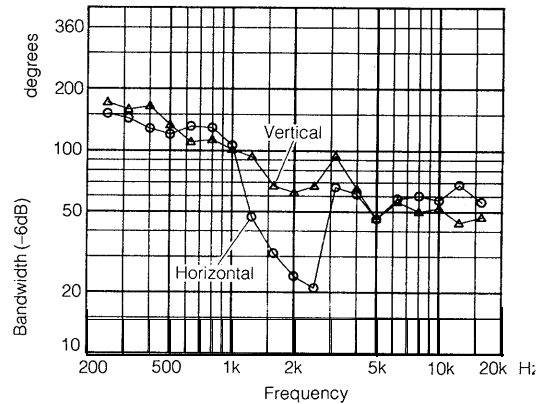

Frequency Response (1W/1m: 1/3 Octave Pink Noise)

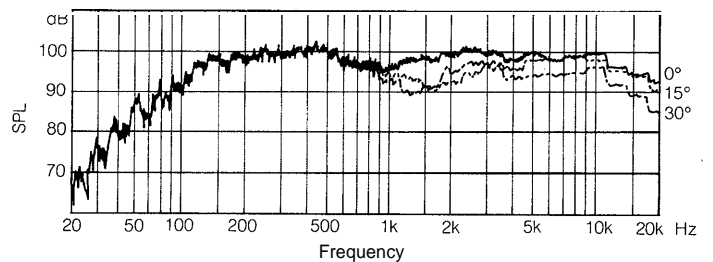

Polar Response

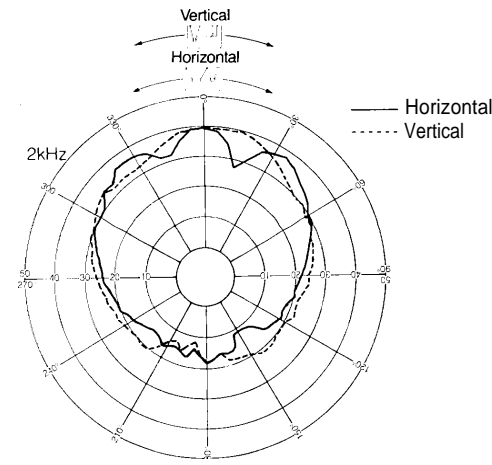
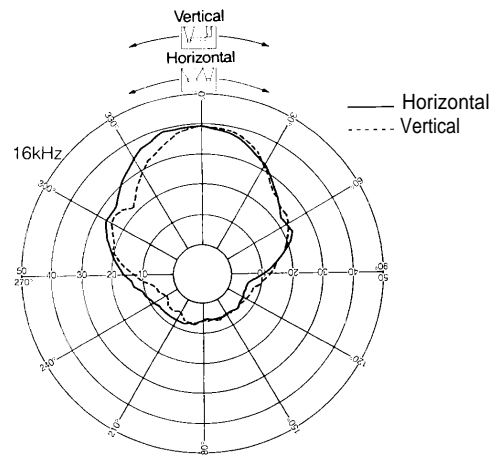
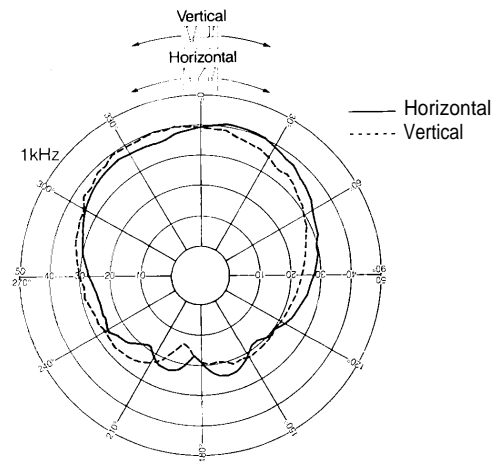
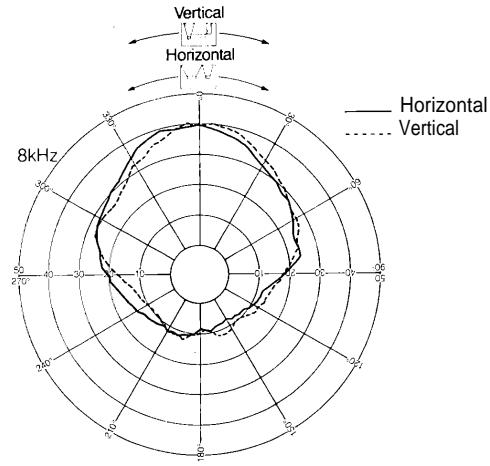
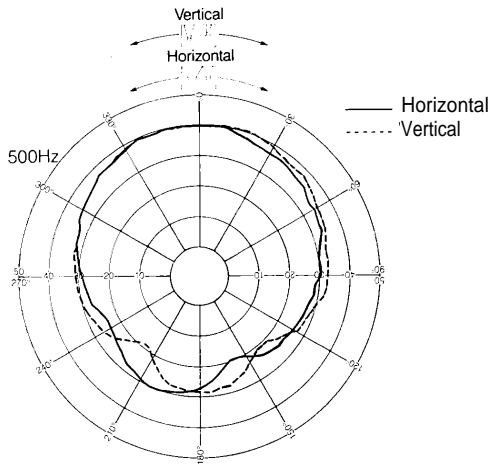
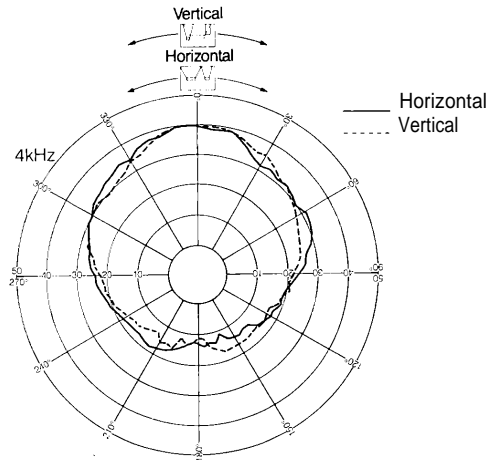
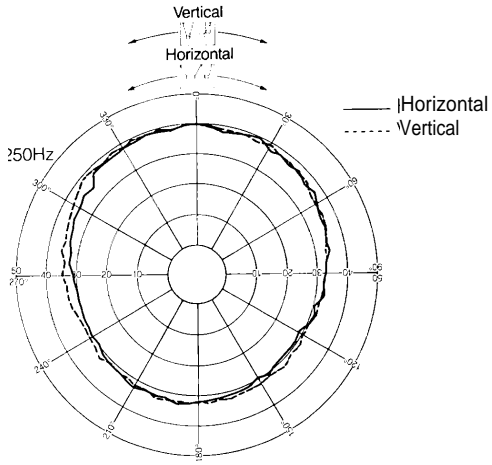

(1W/2m: 1/3 Octave Pink Noise)

SPECIFICATIONS

Enclosure Type	Vented (bass-reflex) type
Speakers	
Low Frequency	30cm (12") woofer
High Frequency	CD horn plus compression driver
Power Handling Capacity	
Continuous Pink Noise	120 watts RMS of band-limited pink noise (40Hz -- 20kHz, 24hrs)
Continuous Program	360 watts
Instantaneous Peak	1,200 watts
Nominal Impedance	a ohms
<hr/>	
Sensitivity	98dB (1W/1m, band-limited pink noise, 230Hz -- 2.5kHz)
Frequency Response	65Hz -- 20kHz
Box Tuning Frequency	65Hz

Crossover Frequency	2kHz
Crossover Slope	18dB/Oct (woofer); 12dB/Oct (tweeter)
Input Terminals	Two 1/4" phone jacks and push-type, both for full-range
Enclosure Materials	Low-foam polypropylene
Color	F-605G: Gray F-605W: Ivory
Dimensions	392(W) x 552(H) x 270(D)mm 15.4(W) x 21.7(H) x 10.6(D) inches
<hr/>	
Weight	17kg (37.5 lb.)
Accessories	HY-30 Ceiling mount bracket (Black) HY-30W Ceiling mount bracket (Ivory)

*Specifications are subject to change without notice